

GERMAN TANK DESTROYER LATE VERSION

JAGDPANTHER

1/16 SCALE REAL RADIO CONTROL BATTLE TANK

(使用说明书)
(INSTRUCTION MANUAL)



FULL OPERATION: FORWARD, REVERSE, REGULAR TURNING, PIVOT TURNING,
A GUN BARREL UP & DOWN, SHOOT BB BULLET.
SIX MODES OF THE AUTOMATIC DEMONSTRATION FUNCTION AND
THE COMPILE PROGRAM AUTOMATICLY FUNCTION.
3 FREQUENCY SELECTION. SUPER CHASSIS. REALISTIC SUSPENSION
SYSTEM. PRE-ASSEMBLED TRACKS. A REALISTIC COMMANDER.

<http://www.henglongtoys.net>
<http://henglongtoys.cn.alibaba.com>

● 使用前详阅本说明书
PLEASE READ THROUGH THIS MANUAL BEFORE USE.



注意：(使用说明书) 使用前详阅本说明书。

Cautions: (Operating Instructions) Please read through this manual before use.

这辆RC(遥控)战车坦克是由无线电控制的模型，而非玩具，装在车内的电动炮和塑料BB弹可发射20-30m，要小心使用，否则会误伤，请详阅下列各点，理解透彻后再作游戏。

This RC (remote controlled) battle tank is not a toy but a tank model controlled with radio signals. It's motor air gun and plastic BB bullets are very powerful with a shooting range of 20 to 30m. Please use carefully to avoid hurts. Please read through the following cautions before use.

坦克装有炮弹，不小心发射或错误使用都会有危险！！ This tank has a built-in motor air gun. Use carefully to avoid hurts by accidental shooting or misuse!!

请戴上护目镜

Please have goggles on.

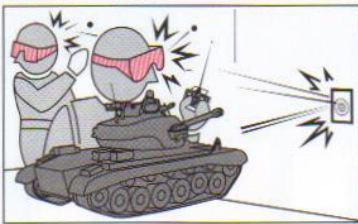

在发射子弹时，本人和周围的人都要戴上护目镜。如果子弹碰到硬物，会弹回伤害到人，要小心。(也要注意勿伤到他人)

All people in the spot should have goggles on when shooting. Please note that the bullet may rebound when it hits something hard. (Make sure no passerby will be hurt.)

游玩后把发射开关置“OFF”。

Set the shooting switch to OFF after use.

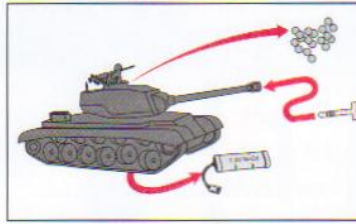

控制后把主开关置“OFF”

① 发射开关置“OFF”

② 插上保护盖

③ 把BB炮弹取出(翻转身，把炮弹取出)

④ 拆下电池(否则由于自然放电会引起漏液)。

Set the main switch to OFF after playing.

① Set the shooting switch to OFF.

② Insert the protective cap into the gun muzzle.

③ Remove the BB bullets. (Turn the tank upside down and pour out the BB bullets.)

④ Remove the batteries. (Otherwise, the batteries may discharge by themselves and cause leakage.)

注意：不可朝人和动物发射。

Caution: Do not shoot at people or animals.

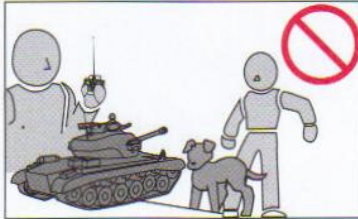

不可让坦克炮瞄准人和动物发射，否则可能以伤害罪被处罚。

Do not aim the gun at or shoot at people or animals. Otherwise, you may possibly be punished for bodily injury.

注意：任何时候都不可窥视发射口。

Caution: Never look into the gun muzzle.



不管里面是否有炮弹，不可窥视发射口，以免伤到眼睛，如无线电波不佳时，由于误操作可能会发射出来，非常危险。

To protect your eyes, never try to look into the gun muzzle, whether there is bullet inside or not. Please also note that accidental shooting may be triggered when the radio signal is poor.

注意：不可在马路等有汽车的地方行走。

Caution: Do not play the tank on the roads.



为避免交通事故，不可在马路行走，也不要在水洼地、砂地等难以行走之处玩，以免发生故障。

Do not play on the roads to avoid traffic accidents. Besides, do not play on water pit, sands, or carpet to avoid malfunction of the tank.

注意：不可在人和汽车横过的地方发射。

Caution: Never shoot in a place where there are people or cars passing by.



在这些场所发射有可能意外伤到人，决不可发射。

If there are other people or cars passing by, shooting may cause danger to them. Do not shoot in such places.

注意：防止小儿误吞零件。

Caution: Prevent part swallowing by little children.



不可把小零件和塑料袋给小儿玩，以免误吞。

Do not give small parts or the plastic bag to little children to avoid accidental swallowing.

注意：不可把手伸入车轮和履带。

Caution: Do not put hands into the wheels or the caterpillars.

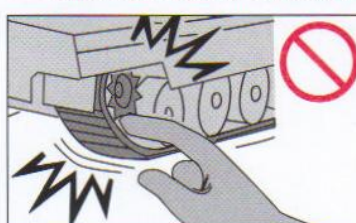

不可把手伸入车轮和履带以免误夹伤，小孩需特别小心，当拿坦克时不可拿住车轮以免由于误操作而受伤害。

Do not put the hands into the wheels or the caterpillars to avoid hurts. Do not touch the wheels or the caterpillars when holding the tank to avoid hurts by misoperation.

注意：不可把天线乱挥舞或把脸靠近它。

Caution: Do not wave the antenna about or get the face too close to it.

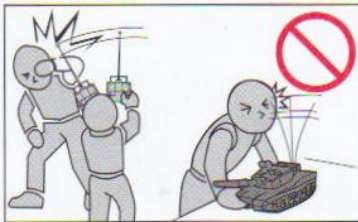

若天线尖端碰到眼睛，可能引起误伤，切不可乱挥舞或把脸靠近它，折断的天线非常锋利，很危险，所以需要到本公司的售后服务部更换。(需付款)

The end of the antenna is dangerous to the eyes. Do not wave the antenna around or get the face too close to it. Besides, if the antenna breaks, the sharp end may be extremely dangerous, please refer to the after-sales service center for (charged) replacement.

注意：错误使用，改造和分解而造成的伤害、事故，本公司概不负责，且不负责改造、分解后商品的修理。

Caution: The company will not be responsible for any hurt or accident caused by user's misuse, alteration or disassembly of the product. And we will not repair products that have been altered or disassembled by the user.

不可把发射口对准容易损坏的物品(如玻璃、灯、家用电器、餐具、家具等)

Do not point the gun muzzle at fragile or other easily breakable articles, such as glass, lamp, electric appliance, tableware, or furniture.

除了本公司指定的BB弹以外，其他子弹容易造成堵塞，不可使用。投入口和发弹口不可放入BB弹以外的其他物品。

Bullets other than the specified BB bullets may easily cause blockage. Do not put any other bullets or other articles into the bullet hatch or the gun muzzle.

使用说明书妥善保管好，丢失时可向本公司邮购。

Keep the manual properly. If it is lost, please contact us for a mail order.

不可强行分解和改造，否则会造成故障和危险，绝对不可以。

Never try to disassemble or alter the product to avoid malfunction or danger.

坦克和遥控器浸入水中或弄湿时可能会出现故障，这时要禁止使用，并拆下电池，与本公司的售后服务部联系。

Because malfunction may be caused when the tank or the remote controller is immersed in the water or gets wetted, stop using immediately and remove all batteries and contact our after-sales service center.

不可把坦克和遥控器置于阳光强烈照射处，否则会变形和误操作。

Do not expose the tank or the remote controller to strong sunlight. Otherwise, they may be deformed or cannot function correctly.

使用说明书 RC Battle Tank Operating Instructions

警告 Warning

注意 Caution

若无视里面的警告，自行进行错误操作，会发生误伤和诱发故障。绝对要遵守各注意事项。
Hurts or malfunctions may be caused if the cautions are neglected. Please abide by all requirements.

注意！ 本战车用于室内竞技，在户外时不可在下列场景使用。 **Caution:** This battle tank is for indoor use only! Please avoid the following misuses.

该战车制作精密，需小心，不可乱碰撞；不可让灰尘、小石等侵入车子内部和齿轮。(遥控器也同样) (否则即使在保修期间也由顾客负担！)
This tank is a precisely-made product and should be used with care. Avoid bumping or dust or sand or stone entering the body or the wheels. (The same requirements for the remote controller) (Otherwise, all related expenditure would be born by the user!)



车子跌落、碰撞等强烈的冲击会造成故障。
Violent shocks caused by fall or bump may lead to malfunction.



不可在有积水的地方行走(遥控器也不可弄湿)
Do not play the tank in a place where it could easily get wetted. (The remote controller should also be kept dry.)



户外的砂地、凹凸不平处，灰尘多的地方也不可行走。
Do not play the tank on sands or other uneven surfaces or in a place with too much dust.



不可在草地、沼泽地等阻力大的地方行走。
Do not play the tank on lawn or other places that may cause excessive resistance.



投入口不可装入指定BB弹以外物品。
Do not put articles other than the specified BB bullets into the bullet hatch.

注意 Caution



使用工具时注意安全
Keep yourself safe when using tools.

- 需另购的物品(遥控器电池) Articles to be purchased (controller's batteries)
- AA电池8粒(用于遥控器) 8X AA Batteries (For controller)

电池的注意事项。
Battery-related caution.

破损 Broken 不可使用破损电池，以免发生短路危险。
Do not use broken batteries to avoid short circuit.



发射时戴上护目镜，确保安全。
Please wear goggles to ensure safe play.



套件内容 Set content

注意

安装附属零件前要检查是否正确操作(见3P 4P 5P 6P 7P)

Caution: Check to make sure the tank functions correctly before installation of the accessories. (See P3, P4, P5, P6, P7)

遥控器 Remote controller

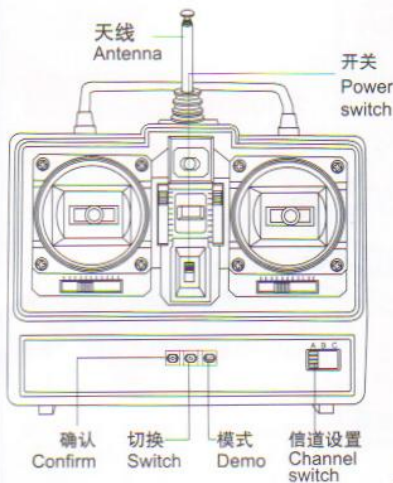

贴纸 Paster



BB弹发射功能配置:
BB shoot function configuration:
BB弹发射保护开关
BB shoot protection switch



BB弹投入口
BB Bullet hatch

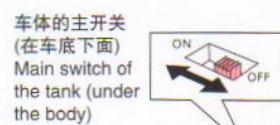

车体的主开关
(在车底下面)
Main switch of the tank (under the body)

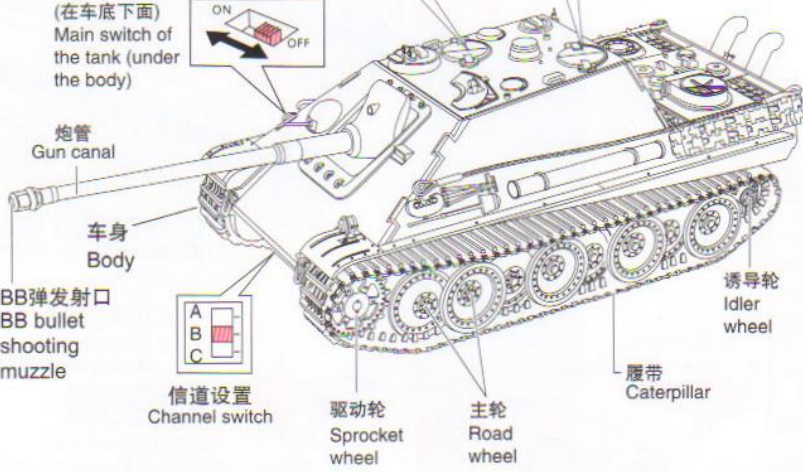

BB弹发射专用
Special for BB shoot

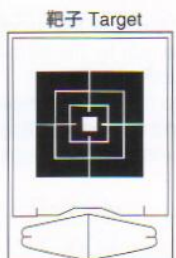

配件盒 (包括小配件和坦克长)
ACCESSORY BOX (Included the small parts and the tank operator)



天线 Antenna



坦克长 Tank operator

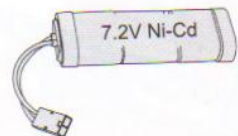

7.2V Ni-Cd 充电电池 Rechargeable battery

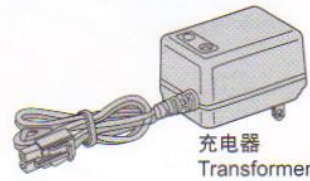

充电器 Transformer

保护盖 Protective cap

保管时务必要盖上保护盖，发射时取下。
(Make sure the cap is always set on the muzzle except when shooting.)

安装零件前务必检查是否正确操作 Check to make sure the tank functions correctly before installation of the accessories.

万一无法正确操作，请联系售后服务部或所购买的商店。

If you find the tank cannot function properly, please contact our after-sales service center or the shop that sold it to you.

注意：装上了零件的商品不能更换，这时被认作是修理。

Caution: It may be difficult for us to replace for the user a tank that has already been installed with the accessories. Only repair service will be available for such request.

警告 Warning

若正负极接反，会引起漏液和故障，要小心。

If the connection is made the opposite, battery leakage or device malfunction may be caused.

1 电池 (遥控器) BATTERY (CONTROLLER)

① 按下电池盖的PUSH，把它拆下。(把开关拨在OFF)

Press down the PUSH on the battery cover and remove it at the same time. (Make sure the switch is on OFF position.)

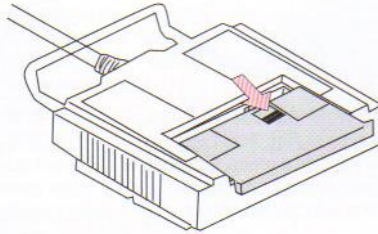

② 正确装好电池。Load in the battery correctly.

注意：装入电池时要与电池盒内所标正负极一致。
Note: The polarity of the battery you install must be the same as shown in the battery cover

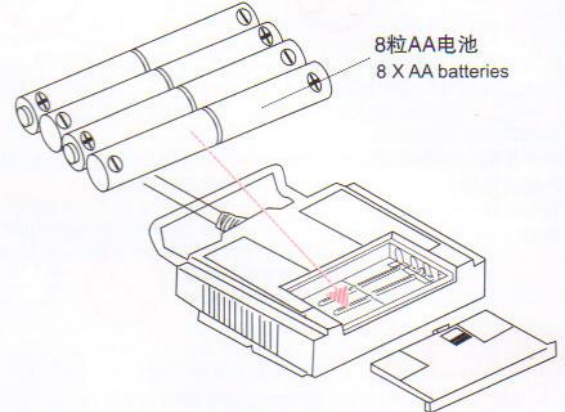

③ 关上电池盖 Replace the cover.

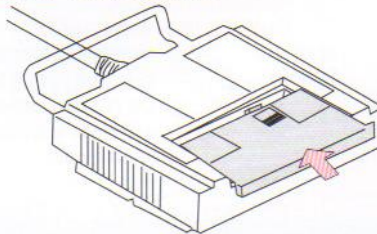

注意：打开车体开关时务必先把遥控器开关置于ON，关掉开关时先将车体开关置于OFF，若次序搞错会引起坦克突然冲出去。
Caution: When turning on power, the remote controller should be first turned ON. When turning off power, the tank should be first turned OFF. If the sequence is not followed, the tank may suddenly rush forward.

2 电池 (车体) BATTERY (TANK)

① 用螺丝批拧开螺丝钉，打开电池盖。

Undo the screw with the screwdriver, and open the battery cover.

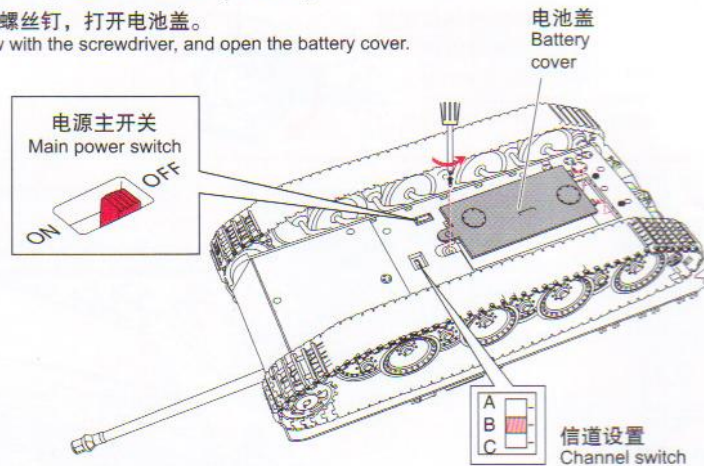

警告 Warning

① 注意手不要被电池的端子割伤。

② 不可把碱性电池和锰电池混用，以免漏液。

① Make sure the hands will not be hurt by the terminals of the battery.

② Do not mix the use of alkaline and manganese batteries to avoid leakage and burn hurt.

② 装入电池。

Load in the battery.

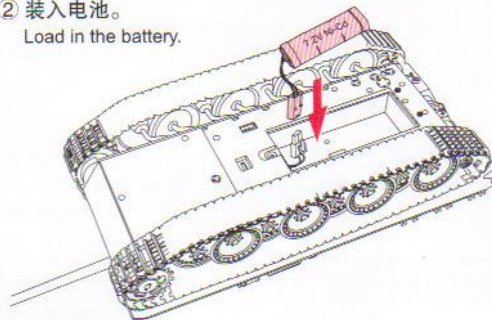

③ 把爪子插好，将电池盖安装好，拧紧螺丝钉。

Insert the claws properly to replace the cover, assemble the battery cover, tighten the screw.

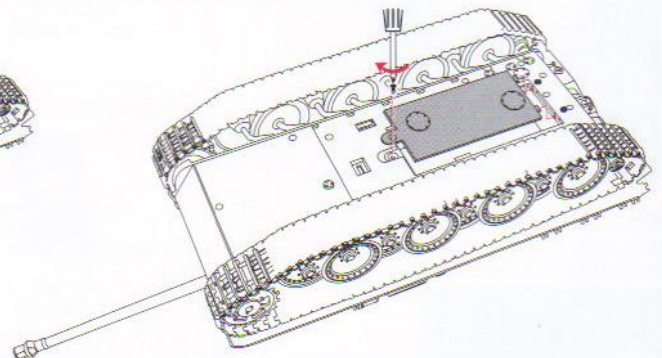

注意 Cautions:

- 打开开关要从遥控器先打开，关开关时则从车体先关，否则可能车子无法行走或突然冲出去。
- 若遥控器和车子太接近，天线接触到其他物品，可能会无法运作或出现错误操作。
- 在室内电波的到达距离会缩短一些。
- 1米以内的近距离需把遥控器的天线缩短些。
- 行走时撞到物体炮身会弯曲不能发射，附属零件可能破损，要小心。

- When turning on power, the remote controller should be first turned ON. When turning off power, the tank should be first turned OFF. Otherwise, the tank may not function normally and may suddenly rush forward.
- If the remote controller is too close to the tank or its antenna touches other articles, the tank may not be properly controlled.
- If the tank is used indoors, controlling range of radio signals may be shortened.
- If the tank is within 1m away from the controller, please shorten the antenna.
- If the gun hits something when moving, it may become bended and unable to shoot.

3 行走的控制 HOW TO CONTROL RUNNING

- 打开开关时先开遥控器再开车体（关掉开关时则相反）

First turn on the remote controller then the tank when turning on power. (Sequence for turning off power is the opposite.)

遥控器各个部分的名称

Controller Parts Identification

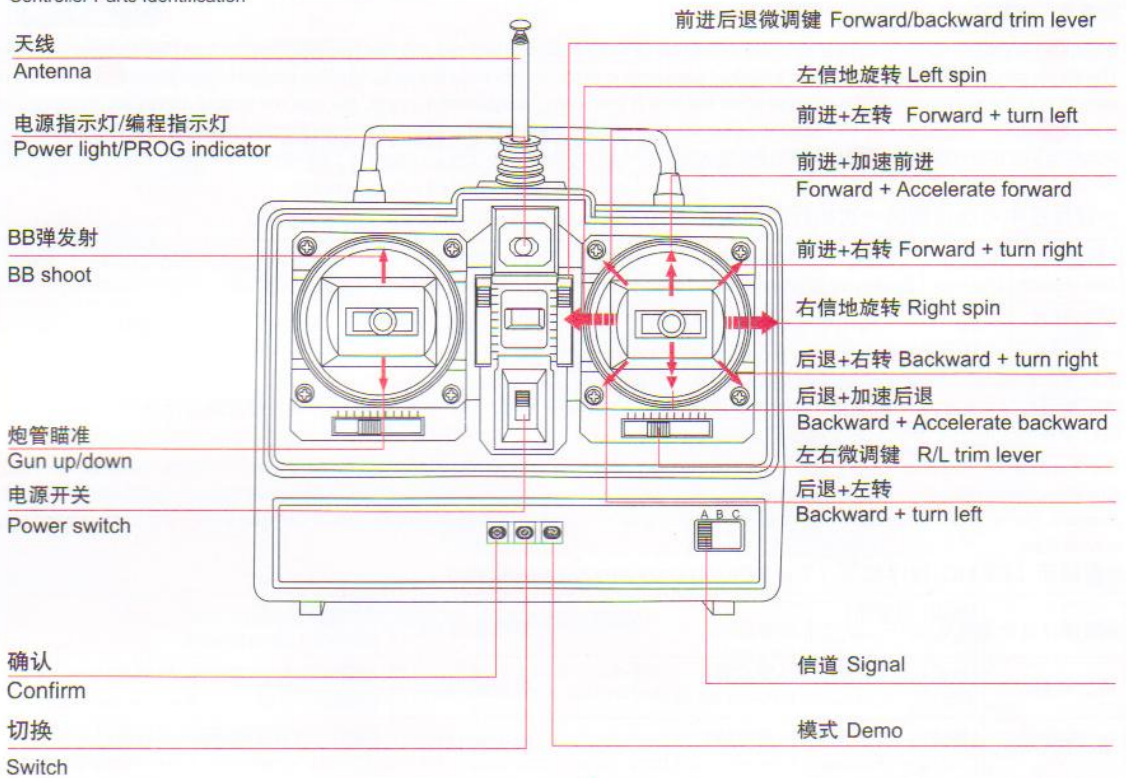

驱动功能全比例无级调速

Full scale drive function limitless timing

注意 Cautions:

- 在阻力比较大的地方和凹凸不平的地方（履带松脱、被东西缠住时）不可强行按下行走操纵杆使车子行走，否则齿轮和马达会发生破坏。

- 如果履带松脱时仍强行操作，可能会弄断它，要先把它装好后，再在上述地方之外的场所行走。

- Do not try to press the running joy stick when the tank is on an even surface or a surface with excessive resistance, or when the caterpillars get loose or entangled with something. Otherwise, the gear wheel or the motor may be damaged.

- In the event that the caterpillar gets loose, any forced movement may cause it to break. Correctly reassemble the caterpillar before you try to operate it.

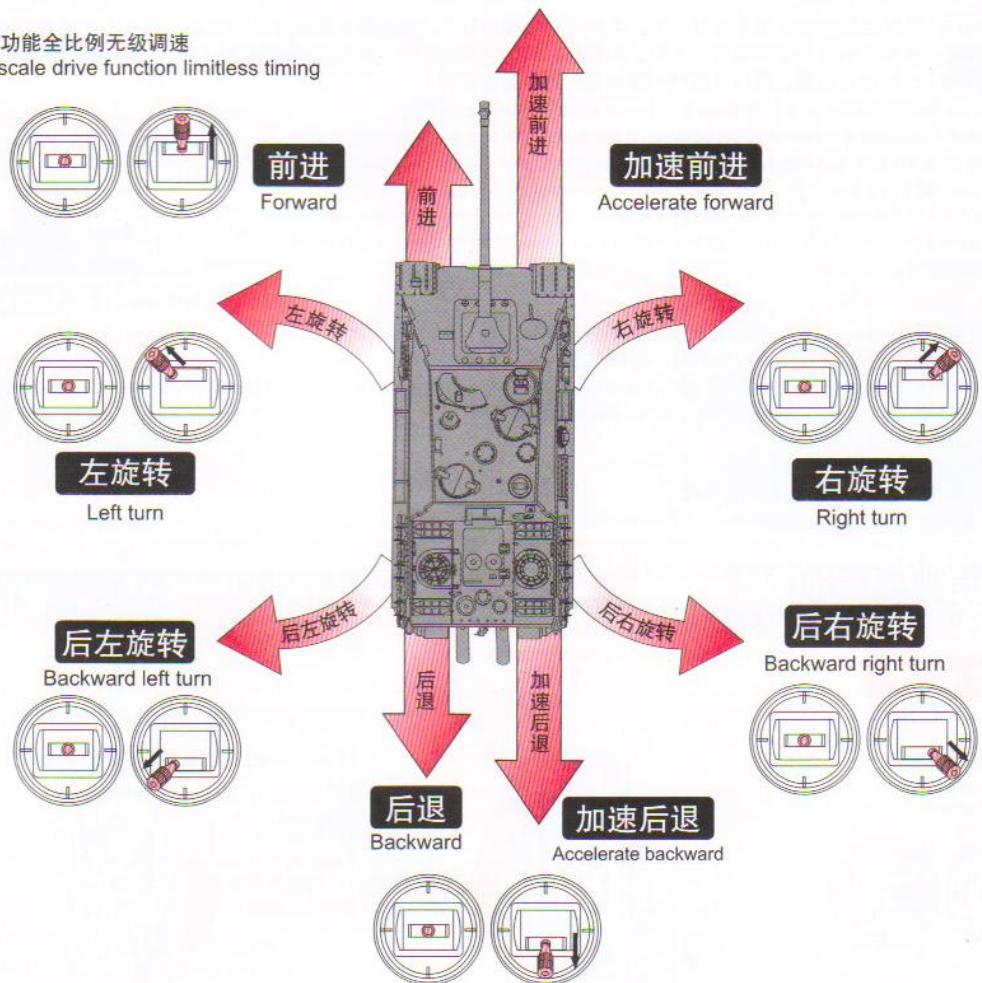

4 使用描述：(HOW TO OPERATE)

1. 在正常操作状态下，按 键一次， 亮红色，坦克车上的 连续闪烁，表示进入编程状态，在此状态下用户可以通过依次按不同的功能键编写一套操作程序，完成后按 键确定，坦克车即按用户编定程序演示；在执行程序过程中。再次按 键，坦克车停止操作并保存所编程序，此时，用户若按 键，则坦克车重复执行刚才编写的程序；若按功能键则重新编写程序并将原有已编程序覆盖；若按 键，则返回正常状态，同时 变黄色，坦克车上的 闪一下。

When is pressed once in normal operation state, the (PROG indicator) turn red and the (Headlight) on the tank start to flash continuously, indicating a programming state. The player can now use function keys in a desired sequence to program moves of the tank. After the programming, press to set the program, and the tank can then move according to the program. If is pressed when the tank is performing programmed moves, the tank will stop all moves and the program is stored. At this time, if the player press once again, the tank will repeat the program that has just been edited, while use of other function keys will initiate a new programming to overwrite the existing program. The player can use to switch the tank back to normal state. The (PROG indicator) will turn yellow accordingly and the (Headlight) on the tank will both flash once.

一套程序中可选功能的一次执行时间长度表 (Lasting time of each move in one program)

按键一次 One pressing	[前进] [Forward]	[后退] [Backward]	[前左进] [Forward left turn]	[前右进] [Forward right turn]	[后左转] [Backward left turn]	[后右转] [Backward right turn]	[炮塔左转] [Turret left spin]	[炮塔右转] [Turret right spin]	[炮塔瞄准] [Turret aim]	[炮塔发射] [Turret shoot]
活动时间 Time	1s	1s	0.25s	0.25s	0.25s	0.25s	0.25s	0.25s	0.25s	发射一弹

2. 本坦克车内部集成了6套固定的演示(模式)程序，按下 键 + 6个方向操作键就可分别调用。在正常状态下，同时按下 键 + 6个方向操作键之一，坦克车进入演示(模式)状态，并执行相应的演示程序，执行完毕后，车体将返回正常状态；若想在执行中即刻返回正常状态，可按 键。

There are six DEMO programs preset in the toy available for use by the player. To use the preset programs, the player can press down and one corresponding key of the 6 direction keys at the same time. In normal state, pressing and one of the six direction keys at the same time will switch the tank to DEMO state and to perform the preset program. The tank will return to normal state after finishing all moves in the program. But the player can also use to terminate the program and switch the tank back to normal state.

六套演示 (DEMO)程序如下:(The 6 DEMO programs are as follows:)

第一套 No.1	[模式] + [前进] [DEMO] + [Forward]	第四套 No.4	[模式] + [后退] [DEMO] + [Backward]
第二套 No.2	[模式] + [左信地旋转+前左转] [DEMO] + [Left spin + Forward left turn]	第五套 No.5	[模式] + [左信地旋转+后左转] [DEMO] + [Left spin + Backward left turn]
第三套 No.3	[模式] + [右信地旋转+前右转] [DEMO] + [Right spin + Forward right turn]	第六套 No.6	[模式] + [右信地旋转+后右转] [DEMO] + [Right spin + Backward right turn]

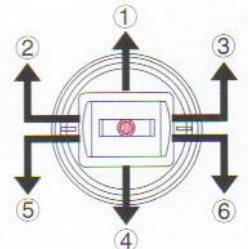

3. 在遥控器和坦克车上各有一个，用户可左右拨动开关上的控制按钮选择不同信道，共有三个(A,B,C)信道可供用户选择，当用户选中某信道后，该坦克车只能接收与该信道匹配的信号，(即，如坦克车的 拨为A，则遥控器上的 也要拨为A，它们一一对应，这样遥控器才能遥控坦克车)；利用此功能，用户可在同一场地同时操作多辆坦克。

The remote controller and the tank both have a (Channel switch). The player can shift the switch to choose a proper channel between 3 channels, 0, 1, and 2. Once the channel is set on the tank, the tank can only accept control signals sent from a remote controller whose channel is also set to the same. (For example, if the (Channel switch) on the tank is set to 1, the (Channel switch) on the remote controller should also be set to 1. Otherwise, the player will not be able to control the tank.) This special function makes it possible for some tanks to play on the same ground at the same time.

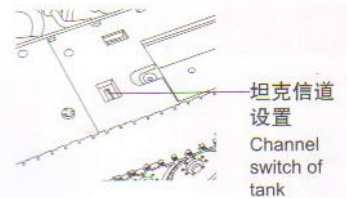
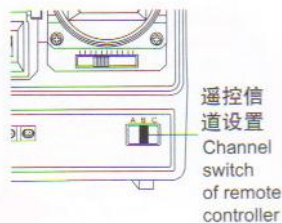

注意事项：(Cautions)

- 区别：若坦克的 慢速闪烁，表示坦克车供电不足，需要更换电池。
若坦克的 快速闪烁，表示坦克车进入编程状态。
Fast flash and slow flash: If both the (Headlight) flash slowly, it means that tank lacks power and the batteries need to be replaced. If they flash fast, it means that the tank has entered programming state.
- 遥控器采用8粒AA电池供电。
The remote controller is powered by eight X AA batteries.
- 坦克车采用1组Ni-Cd 7.2V充电电池供电。
The tank is powered by one group of Ni-Cd 7.2V rechargeable batteries.

5 超信地旋转的控制

HOW TO CONTROL SUPER SPINS

何谓“超信地旋转”？即通过使左右履带逆向旋转来使车体的方向改变的旋转。
What is "Super Spin"? A kind of spin of the tank performed by controlling the two caterpillars to run at the opposite directions.

左超信地旋转 Super Left Spin

把右操纵杆向左拨。
Turn the right joy stick to the left side.

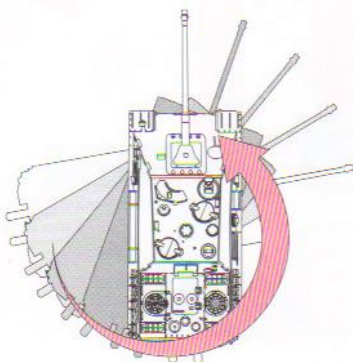
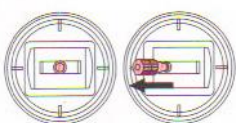

右超信地旋转 Super Right Spin

把右操纵杆向右拨。
Turn the right joy stick to the right side.

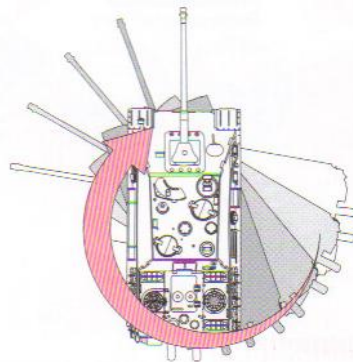
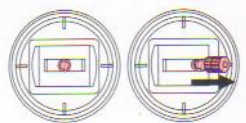

警告 Warning

当出现干扰电波，电波状况变差时，有可能因错误控制而造成突然发射，在这种情况下不可发射BB弹或行走。(炮塔内部的开关置OFF，发射口盖上保护盖)

When control is interfered by other radio waves or the control signals are not strong enough, the tank may not act correctly and may shoot accidentally. Immediately stop tank running and shooting in such circumstances. (Remember to turn off the switch inside the turret and put the protective cap onto the gun muzzle.)

注意 Caution

● 这个RC坦克规范的最大射程约25米，根据发射时的情况(炮身仰角和风速等)而变化。

The maximum shooting range of the RC tank is 25m, which may differ according to actual shooting conditions, such as vertical angle of the gun and wind speed.

警告 Warning

● 发射时要注意周围是否安全。
● 发射时周围的人要戴护目镜。
● 有时候以为弹全部发射完了，但在车体内部有可能剩余子弹。若无意中撞击而发射会造成危险，要小心。

● 使用后把BB弹发射口装上保护盖，车子主开关和发射开关都置OFF，取出BB弹和电池，保存于安全之处。

● Shooting can only be carried out in a safe environment.

● People in the shooting spot should all wear goggles.

● Sometimes bullet remains inside the tank but you think no bullet remains. It's dangerous because the bullet may be shot out accidentally.

● After use, remember to put the protective cap onto the gun muzzle, turn off the main switch and the shooting switch on the tank, remove BB bullets and batteries, and store them in a safe place.

注意 Caution

发射时炮塔要处在水平。

Turret should stay horizontal when shooting.

在发射系统的构造上，炮塔部分的左侧朝下时，或者炮塔后部朝下则BB弹无法给弹，因而无法发射。

According to the design of the turret, if the left side or the back side of the turret is lower than their counter sides, bullets can not be loaded and shooting becomes impossible.

6 炮塔部分的控制

HOW TO CONTROL TURRET

打开开关时先开遥控器的开关，再开车子的开关，关掉开关时则相反操作。

First turn on the remote controller then turn on the tank when turning on power. Sequence for turning off power is the opposite.

炮身上下

Gun Up/Down

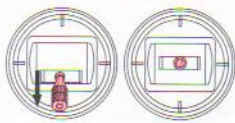

按下炮管上下控制杆。

Press the GUN UP/DOWN joy stick.

※若连续按下炮管上下控制杆就能上下变化。

※ The gun can continuously and alternately move up and down when the joy stick is kept pressed.

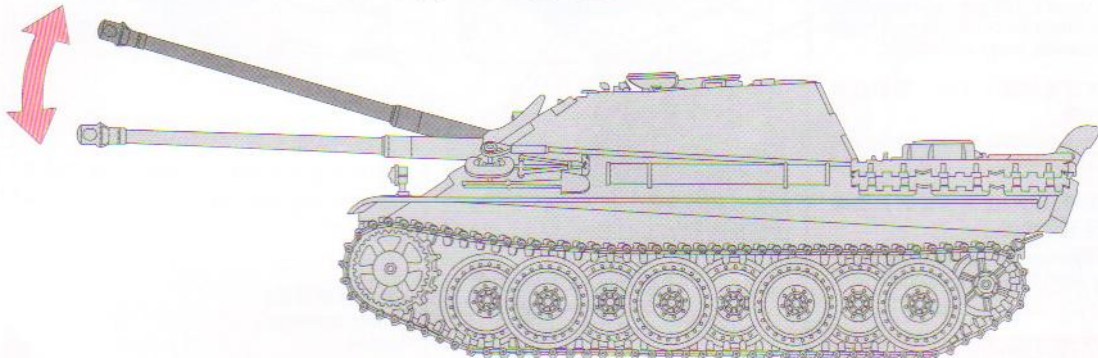

注意 Caution

发射子弹时参照7P⑦装好子弹，把发射开关置ON 拆开保护盖。

Caution

To prepare for shooting, load in BB bullets as shown in 7P⑦, turn on the shooting switch and remove the protective cap.

● 如果装着保护盖时发射BB弹则内部机构会损坏。

Shooting with protective cap on the gun muzzle may cause damages to the inner mechanism.

※在即将发射前，BB弹发射警告灯会亮起来

※ The BB shooting indicator will light up right before the bullet is shot out.

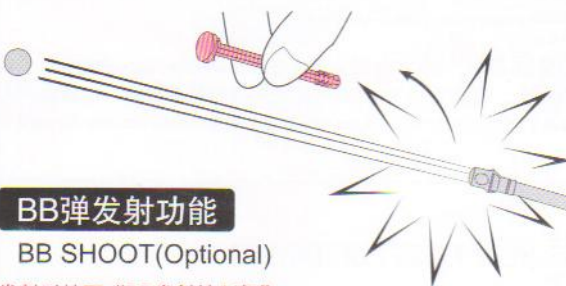
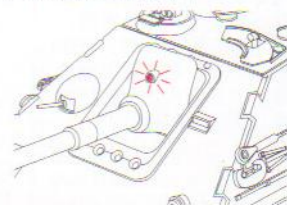

BB弹发射功能

BB SHOOT(Optional)

发射时按下“BB发射控制杆”

To shoot, press the BB SHOOT joy stick.

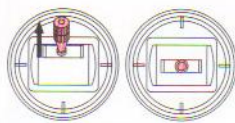

按下发射控制杆

Press BB SHOOT joy stick.

※连续按下控制杆则发射运作会重复

※ Shooting continues when the joy stick are kept pressed.

注意 Caution

主开关和炮塔内发射开关没有打开就无法发射(7P⑦)

The gun cannot shoot when the main switch and the shooting switch inside the turret are set to OFF.

推荐：组合各种操作，实现逼真的战术运作。

Suggestion: Operations can be combined to simulate actual tank moves.

例：

行走 + 上下 = 边走边炮身上下动作。
Run + Up and down = The tank gun moving up and down while running.
行走 + BB发射弹 = 边走边发射BB弹。
Run + BB shoot = The tank shooting BB bullets.
旋转 + BB发射弹 = 变方向的同时发射BB弹。
Turn + BB shoot = The tank shooting BB bullets.

※除此之外你可以想出其他各种变化。

※ You can think out other new combinations.

注意 Caution

复合动作会使电池的消耗增加 Combinations consume more battery power.

注意 Caution

●使用过的BB弹沾上了灰尘，不可再用

Once shot out, the BB bullet becomes dirty and not suitable for reuse.



●若BB弹附有灰尘和砂子，可能会堵塞弹道，并导致内部故障。
If BB bullets with dirt or tiny sand on are used in the gun, the gun barrel may easily be blocked and the inner mechanism may be damaged.

●不可强行装入子弹，否则会发生故障。
Improper loading of bullets may lead to malfunction.

●使用0.2g以上的重弹时，子弹飞得不会太远。

If the bullets used weigh over 0.2g, they won't be shot far enough.

如果子弹堵塞

If the bullet jam

●如果弹匣中进入灰尘等，BB弹的流动不会顺畅，无法很好地发射，甚至会引起子弹堵塞。出现这种情况时要立即停止发射，把弹匣朝下轻轻摇动战车，把BB弹和灰尘倒出来，甚至可以把炮塔盖拆下，从间隙吹入气体把灰尘吹出来后再装入BB弹。

If dirt or dust gets into the bullet hatch, the rolling of the bullets may be disturbed, making shooting difficult or even impossible. In such circumstances, turn the tank up side down for the bullet hatch to face down and slightly shake for the dirt or dust to fall out. If necessary, you can also remove the cover of the turret and blow into the gap to clean up the dirt before loading in bullets.

7 BB弹的装填 HOW TO LOAD BB BULLETS

① 打开BB弹投入口，约投入35颗BB弹。

Open the bullet hatch and put in about 35 BB bullets.

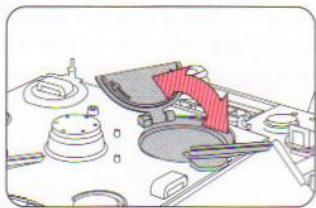

② 关闭BB弹投入口。

Close the bullet hatch.

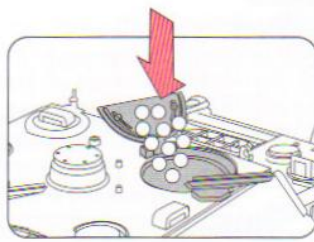

使用下列不良炮弹会损坏内部机件
Use of the following bad bullets may lead to internal damages.

✗ 超过6mm直径的BB
BB of a diameter over 6mm

✗ 偏心的BB
Eccentric BB

✗ 有凸部的BB
BB of uneven surface

※弹道改良系统的说明
※briefing of hop-up system

○ 弹道改良系统的弹道 Ballistic trajectory with hop-up system.



没有弹道改良系统的弹道 Ballistic trajectory without hop-up system.

RC坦克上带有弹道改良系统 The RC tank is equipped with hop-up system.

这个系统通过一定的空气压力，在发射出去的BB弹上加上强烈的后旋转，这样就产生上升力使子弹尽量向远方发射。Influenced by the system, the shot out BB bullet will forcefully spin back while running forward at high speed, generating climbing power to go further ahead.

③ 发射开关要置ON才能发射。

Set the shooting switch to ON.

发射开关（安全装置）通常置于OFF状态，发射时再拨至ON。

The shooting switch (safety device) is normally kept OFF. Only for shooting can it be set ON.

(发射保护开关)
(Shoot protecting switch)

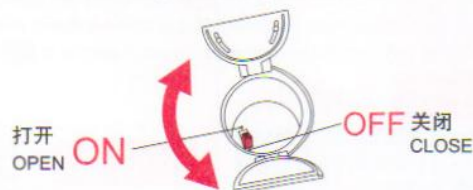

■ 如下图所示，发射距离大幅度提高

Flying distance becomes much longer, as the picture shows.

8 靶子的安装 HOW TO SET UP TARGET

●向靶子射击，使发射更具有乐趣

Enjoy shooting using the attached target.

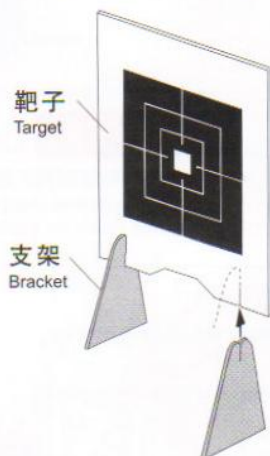

注意 Caution

无需螺丝，牢固地插好
No screws needed for the setup.

●把靶子对准支架的缺口，如图插好。

Firmly insert the target to the holding gaps on the supports.

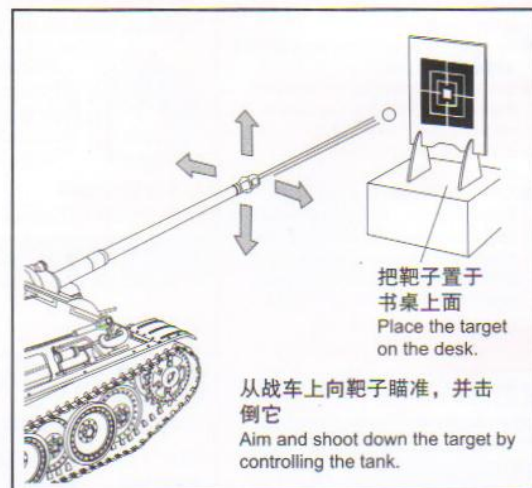

把靶子置于书桌上
Place the target on the desk.

从战车上向靶子瞄准，并击倒它

Aim and shoot down the target by controlling the tank.

要点

要正对靶心射击，则要从战车的正后方瞄准，使炮身在动作的同时找到感觉进行发射

Points:

Aim at the bull's eye from the back of the tank before shooting. Fire during the aiming moves of the gun to shot down the target.

配件盒
ACCESSORY BOX

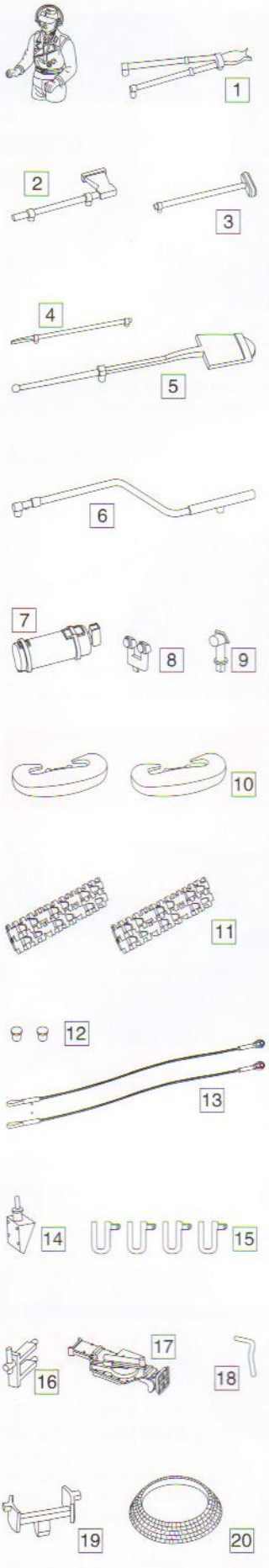

9 附属零件的安装 HOW TO INSTALL ACCESSORIES

坦克长的安装
To install the
tank operator.

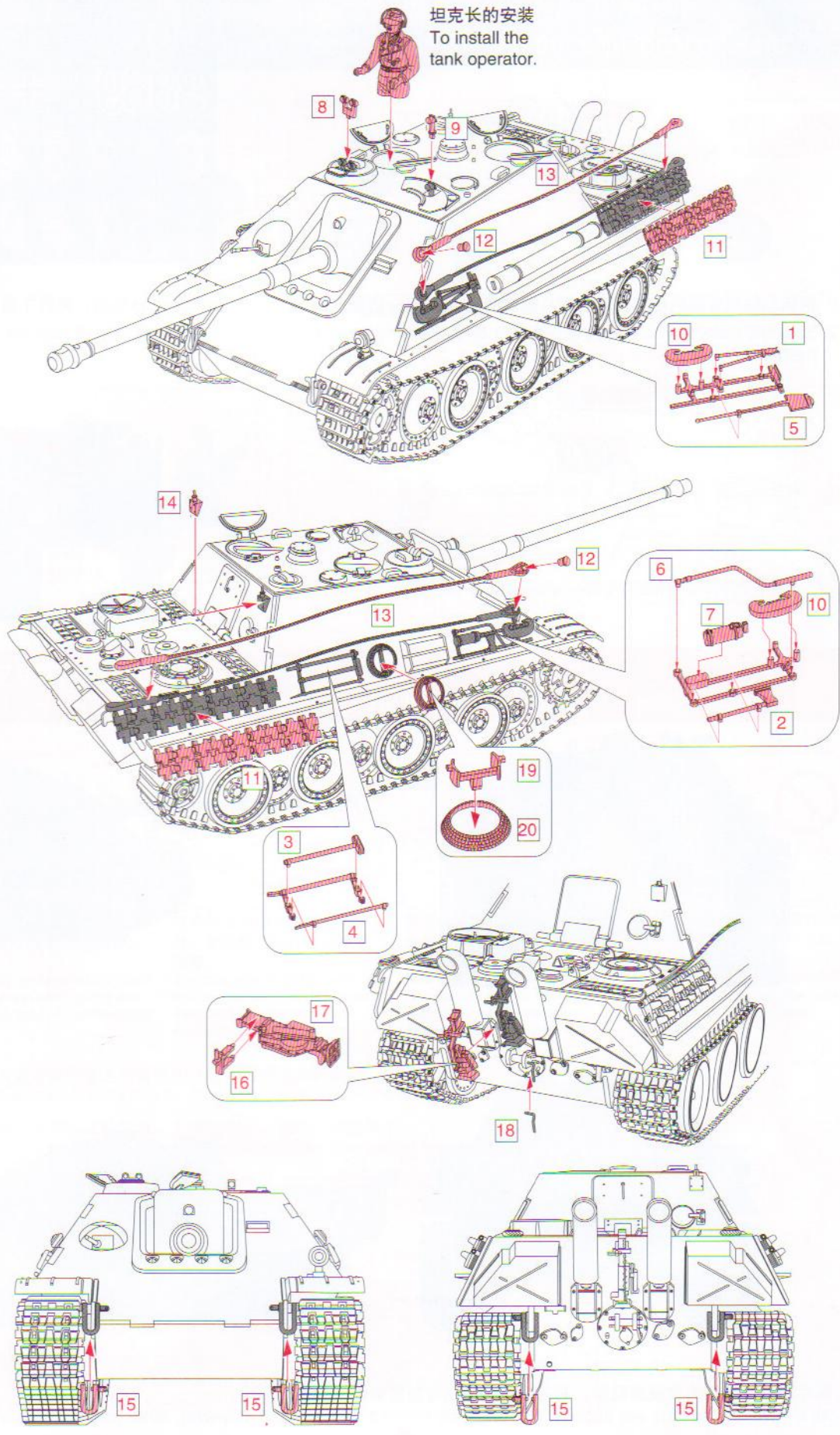

10 部队番贴纸的贴法 HOW TO STICK MARK SEALS

1. 从要贴的标志从贴纸中取上来。

1. Take the proper seal with a pair of forceps.



2. 把标志贴到所需的位置，然后再从贴纸的一边到另一边紧压一下。

2. Stick the mark to you need the position, then pressing down the paster.

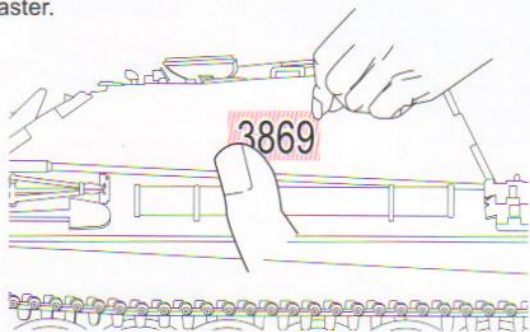

3. 待十五分钟后，再撕下透明膜。

3. After wait for 15 minutes, then tears down the transparent film.

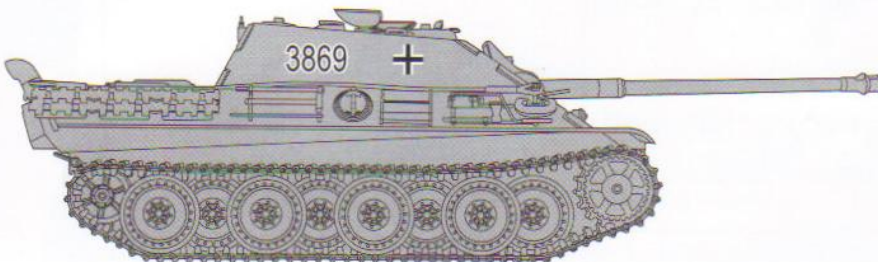
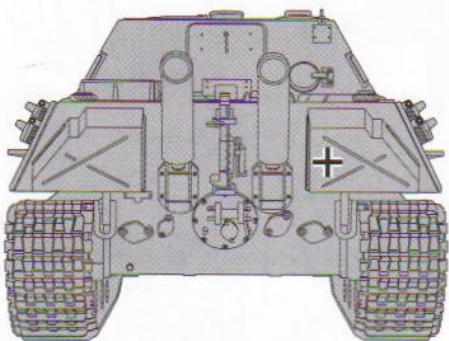
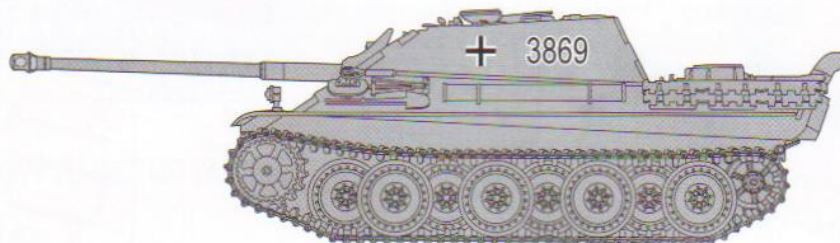
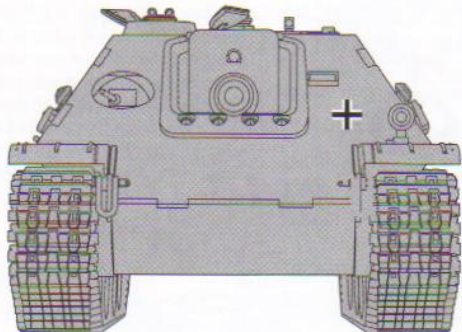
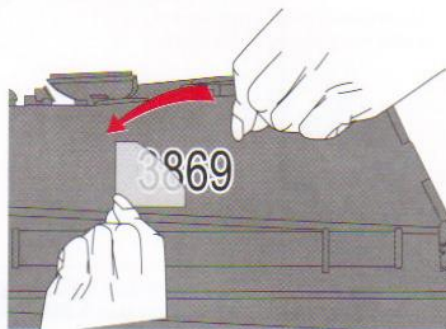

图示所贴标纸，为产品原贴法，其它贴纸供使用者随意装饰。

As shown, the pasters are according to originally product stick method, however, other pasters decorates at will for the user.

升级选购件 Hop-up optional parts

下列是可供选择的升级选购件，可通过当地的经销商购买配件。
The following are optional parts for upgrading can be purchased through local dealers.

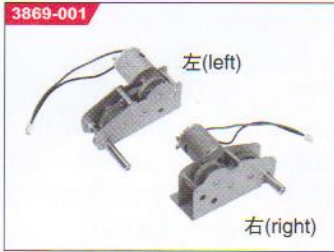

3869-001
金属齿轮驱动箱(锌合金/钢质齿轮)
Metal gear drive box
(Zinc alloy/Steel gear Tank operator)



3869-002
金属履带
Metal caterpillar



3869-003
金属驱动轮(含螺丝)
Metal driving wheel(Included screws)



3869-004
金属诱导轮(含螺丝)
Metal idler(Included screws)



3869-005
内六角扳手(2.5mm)
Inner hexagon spanner(2.5mm)



3869-006
坦克长和士兵
Tank operator & soldier

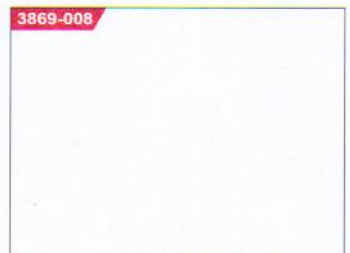
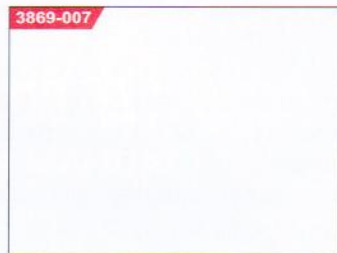

修理时须知：以下情况即使是保修期间也要付款

Note: Repair services to damages caused by the following reasons are to be charged, whether within the term of quality guarantee or not.



1 掉落、强烈撞击造成的故障。

Accidental fall or strong bump, which leads to tank or controller damages.



2 在积水和潮湿处行走，被水弄湿(包括遥控器)造成的故障。

The tank (or the remote controller) is wetted when running in a wet place, which leads to malfunctions or breaks.



3 在户外泥地沙地、凹凸不平处、灰尘多之处行走造成的故障。

The tank runs in a place with too much sand, mud, dirt, or on an even surface, which leads to malfunctions or breaks.



4 在地毯、草地等阻力大的地方行走而造成的故障。

The tank runs on carpet, lawn or other places with excessive resistance, which leads to malfunctions or breaks.



5 在BB弹投入口放入指定BB弹以外物品而堵塞造成的故障。

Articles other than the specified BB bullets are put into the bullet hatch, which leads to inner blockage.

6 使用过的BB弹因为附上灰尘，绝对不可再使用以免造成故障
Dirty or used BB bullets or other bullets are used in the tank, which leads to malfunction or breaks.



使用污染的BB弹，用过的BB弹和指定以外的BB弹而造成的故障。

BB bullets that have been used may get dirt on them and cannot be reused to avoid damages to the tank.

7 没有遵守说明书上的警告和注意事项而造成的故障。
Other malfunctions due to violation of warnings or cautions described in this manual.

8 错误使用而造成的故障。(电池接反，弄湿，碰撞等)
Malfunctions due to misuses (reverse battery connection, wetted parts, or bumps).

9 不当的分解和改造而造成的故障，或使用本公司以外的零件。
Malfunctions due to improper assembly or restructuring or use of unspecified parts.

10 购买后由于输送，掉落造成的故障，或保管不周。
Malfunctions caused during moving or by falls or by poor storage condition.

11 使用所指定以外的电池造成的故障，强行在阻力大的地方行走而损伤主板和马达。
Malfunctions caused by use of unspecified batteries. Chassis or motor damages caused by running over places with excessive resistance.

12 其它保证规定之外的故障和损伤。
Other malfunctions or breaks not within the range of our quality guarantee.

※改造或分解的商品不受理维修。

※The manufacturer does not offer repair services for commodities restructured or disassembled by the user.



即使是在重视使用电子装备的信息战的今天，战场上互相追求高科技兵器的威力，但陆地战争起到主导作用的依然是坦克，它具有压倒性的强大装备，具有疾风怒涛般的机动力，具有令人畏惧的大炮毁灭力。坦克在全世界爱好者的眼中，是梦寐以求的理想战斗机器。

过去，有数以千计的仿真坦克被制造出来，受到全球几代人的喜爱；有木制的、塑料的、带马达的、有线式的、无线控制的等等。这不计其数的坦克使人们的梦想得以实现。今天，在这辉煌的历史中，提出了“最新的，具有纪念意义的新一页！”的口号，作为研制开发的指南。

这种结果就实现了超逼真的外观。与1/35、1/60这两种原来的模式相比，1/16这种模式远远地超越了它们。它实现了大型化，在各细节上也能忠实地模仿原来的样式，而且1/16这种尺寸是公认的国际规格。由于与其他多数的车模尺寸相同，它们与本品同时展出可以衬托出“GERMAN TANK DESTROYER JAGDPANTHER LATE VERSION”战车的存在感和逼真形象。

第1个销售的卖点是它的行走性能，作为现代的最新型战车，“GERMAN TANK DESTROYER JAGDPANTHER LATE VERSION”动作敏捷，能够挑战遥控车的极限。前进、后退、左转和右转就不用说了，作为坦克特征的履带动作、信地旋回、超信地旋回也可以实现，坦克使用全比例遥控，前进后退速度可自由控制，让我们领略各种方式行走的乐趣。

第2个销售的卖点是炮塔能够左右旋转、炮身上下运动。这样，就与实物一样能够准确地对准目标而不会漏掉！主炮是正式的电动炮（具有弹道改良系统）BB弹的射击距离约25米，而且与实物同样是自动装填式的。

第3个销售卖点是它的仿真声、启动点马达声、发动机声、发炮声及发炮振动、机关机声、发动机熄火声及冒烟功能，使操作者身临其境。

第4个销售卖点是新增的红外线对战系统，使坦克的攻击更具杀伤力，实现了高度的逼真性。

当BB弹发射时，“GERMAN TANK DESTROYER JAGDPANTHER LATE VERSION”战车的“直接瞄准孔”上安装的“BB弹发射警告灯”就会亮起来，以防止无意间误发射。同时，让坦克像活物一样具有表情（好像瞄准猎物的猎手一样）！

“前进”“瞄准”“发射”实物战车具有的动作都能够实现，这就是最新高科技研制的战车的精髓！

色调和图案也能逼真地再现实物形状。迷彩喷涂和车体主要部件喷涂完成的机体和控制器使每个人都可欣赏到行走和BB弹发射的妙趣。还有安装上了坦克长；今后陆续推出的各样新款配件都将使游戏更具情趣。

新感觉的遥控器操纵非常方便，所以边行走边转向和发射BB弹的复合动作也会十分方便！电源则使用充电电池，控制器使用8粒AA电池。可实现连续约20分钟的行走，由于可以更换不同的晶体，可以实现多台战车同时行走而不会互相干扰。这样你可以和其他人或者朋友各自拿出自己最得意的战车来比赛，甚至进行战斗！

“创造、技术、品质！”是本公司面向21世纪的三个口号，而“1/16 RC战车系列”则完全和以上口号相吻合，本公司将致力于为车迷着想，为广大爱好者做出新贡献。

Introduction of RC Battle “GERMAN TANK DESTROYER JAGDPANTHER LATE VERSION”

Today, while modern war depends more and more on information and high-tech electronic equipment and electronic weapons, tanks still play a key role in ground wars. Well known for strong driving power and mass destructive gun, they are ideal weapon for military fans around the world.

During the past decades thousands of simulated tanks have been developed and been favoured by generations of people worldwide. Technology is gradually developed, starting from the first wood-made mold to motorized one then to wire-controlled one. Finally here come the wireless controlled molds. Now it is time for us to seek another breakthrough in the history of tank molds.

As a result of our research work, a whole new model, RC battle “GERMAN TANK DESTROYER JAGDPANTHER LATE VERSION” (1/16 scale) with vivid look, has made its debut on the market. Compared with the former models of 1/35 and 1/60 scales, it is much larger and simulates more details of a real tank. Besides, the commonly accepted scale of 1/16 makes it more real and outstanding if displayed together with other models of the same size.

The first sales point is its excellent maneuvering performance. As the latest modern tank, it has high agility and exceeds the limits of moves of traditional remote controlled cars. Except normal moves, such as forward run, backward run, left turn, and right turn, it can perform spin stunt and super spin stunt with caterpillars, which are unique and characteristic moves of a tank. Because the tank uses full scale R/C function, speed forward and speed backward can be controlled allowedly.

The second sales point is that its turret can turn sideways and the gun can move up and down, imitating actual aiming acts of a tank. The powerful motor air gun (with hop-up system) can shoot BB bullets as far as 25m. What's more, the bullets can be loaded automatically, just like a real tank.

The third sales point is that its emulational music、simulative motor start-up sound、engine sound、machine-gun sound and cannonball sound, and smoking function, let the manipulator is personally on the scene.

The fourth selling points is that the newly added infrared battle system so that the tank attack more lethal, to achieve a high lifelike.

There is a indicator for BB bullet shooting near the direct aiming hole on the battle tank. It will light up before shooting, warning people of the shooting and making the tank more like a real hunter.

"Run forward! Aim! Shoot!" All these acts of a real battle tank can be performed by this simulated tank.

The color and pattern on the body of the model also perfectly resemble a real tank. The camouflage coating on the tank makes running and shooting more interesting. There is also a tank operator, designed to make the game more attractive. The handy-type controller is easy for use. Only one hand is enough when controlling basic moves of the tank. And you can also use it to control many complicated moves. For example, the tank runs and turns and shoots at the same time.

The tank is powered by rechargeable battery, while the controller uses eight AA batteries. If fully powered, the tank is run continuously for about 20 minutes. Moreover, the tank can change different crystal for more than 1 tank to run at the same time without interference.

"Creativity, Technology, Quality" These are the 3 slogans of our company for the new century, which are embodied in our 1/16 RC battle tank series. In the future, we will try our best to offer you more quality products.