

VIVID SIMULATION OF ACTIONS OF ACTUAL BATTLE TANK

Snow leopard

1/16 SCALE RADIO CONTROL BATTLE SMOKING TANK
AUTOMATIC ELECTRIC GUN SYSTEM INSTALLED. PERFECT ACTIONS RADIO CONTROL BATTLE TANK.

使用說明書 INSTRUCTION MANUAL



◆ 啓動熄火裝置

START-UP/ EXTINGUISH SET

◆ 全比例遙控

FULL SCALE R/C FUNCTION

◆ 仿真冒烟 可開關控制

REALISTIC SMOKING FUNCTION

◆ 仿真馬達啓動聲、發動機聲、機關槍聲、炮聲、帶仿真動作
聲音可以調節

SIMULATIVE MOTOR START-UP SOUND、ENGINE SOUND、MACHINE-GUN SOUND、
CANNONBALL SOUND. EMULATIONAL ACTION EFFECT . THE SOUND CAN ADJUST.

NEW ACCESSORIES
REALISTIC SMOKING FUNCTION
**OVER 1 TANK CAN
PLAY AT THE SAME TIME**



HENG LONG
NO.3819-1



注意：(使用說明書) 使用前詳閱本說明書

Cautions: (Operating Instructions) Please read through this manual before use.

這輛RC(遙控)戰車坦克是由無線電控制的模型，而非玩具，裝在車內的電動炮和塑料BB彈可發射20-30m，要小心使用，否則會誤傷，請詳閱下列各點，理解透徹後再作遊戲。

This RC (remote controlled) battle tank is not a toy but a tank model controlled with radio signals. It's motor air gun and plastic BB bullets are very powerful with a shooting range of 20 to 30m. Please use carefully to avoid hurts. Please read through the following cautions before use.

坦克裝有炮彈，不小心發射或錯誤使用都會有危險！This tank has a built-in motor air gun. Use carefully to avoid hurts by accidental shooting or misuse!

請戴上護目鏡

Please have goggles on.



在發射子彈時，本人和周圍的人都要戴上護目鏡。如果子彈碰到硬物，會彈回傷害到人，要小心。(也要注意勿傷到他人)

All people in the spot should have goggles on when shooting. please note that the bullet may rebound when it hits something hard. (make sure no passerby will be hurt.)

注意：不可朝人和動物發射

Caution: Do not shoot at people or animals.

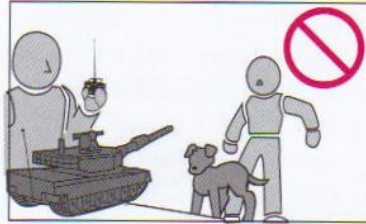

不可讓坦克炮瞄準人和動物發射，否則可能以傷害罪被處罰。Do not aim the gun at or shoot at people or animals. Otherwise, you may possibly be punished for bodily injury.

注意：不可在馬路等有汽車的地方行走

Caution: Do not play the tank on the roads.

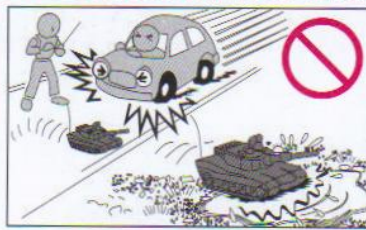

為避免交通事故，不可在馬路上行走，也不要在水窪地、砂地等難以行走之處玩，以免發生故障。Do not play on the roads to avoid traffic accidents. Besides, do not play on water pit, sands, or carpet to avoid malfunction of the tank.

注意：防止小兒誤吞零件

Caution: Prevent part swallowing by little children.

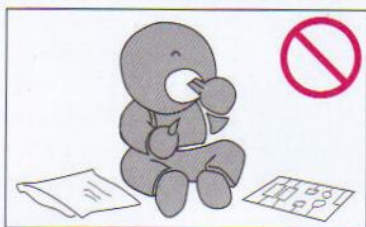

不可把小零件和塑料袋給小兒玩，以免誤吞。Do not give small parts or the plastic bag to little children to avoid accidental swallowing.

注意：不可把天綫亂揮舞或把臉靠近它

Caution: Do not wave the antenna about or get the face too close to it.

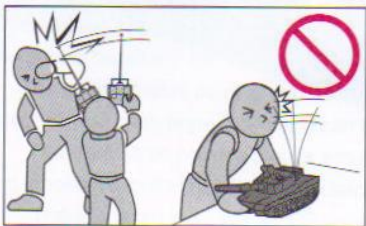

若天綫尖端碰到眼睛，可能引起誤傷，切不可亂揮舞或把臉靠近它，折斷的天綫非常鋒利，很危險，所以需到本公司的售後服務部更換。(需付款)
The end of the antenna is dangerous to the eyes. Do not wave the antenna around or get the face too close to it. Besides, if the antenna breaks, the sharp end may be extremely dangerous, please refer to the after-sales service center for (charged) replacement.

注意：錯誤使用，改造和分解而造成的傷害、事故，本公司概不負責，且不負責改造、分解後商品的修理。

Caution: The company will not be responsible for any hurt or accident caused by user's misuse, alteration or disassembly of the product. And we will not repair products that have been altered or disassembled by the user.

不可把發射口對準容易損壞的物品(如玻璃、燈、家用電器、餐具、家具等)

除了本公司指定的BB彈以外，其他子彈容易造成堵塞，不可使用。投入口和發彈口不可放入BB彈以外的其他物品。

使用說明書妥善保管好，丟失時可向本公司郵購。

不可強行分解和改造，否則會造成故障和危險，絕對不可以。

坦克和遙控器浸入水中或弄濕時可能會出現故障，這時要禁止使用，並拆下電池，與本公司的售後服務部聯繫。

Do not point the gun muzzle at fragile or other easily breakable articles, such as glass, lamp, electric appliance, tableware, or furniture.

Bullets other than the specified BB bullets may easily cause blockage. Do not put any other bullets or other articles into the bullet hatch or the gun muzzle.

Keep the manual properly. If it is lost, please contact us for a mail order.

Never try to disassemble or alter the product to avoid malfunction or danger.

Because malfunction may be caused when the tank or the remote controller is immersed in the water or gets wetted, stop using immediately and remove all batteries and contact our after-sales service center.

Do not expose the tank or the remote controller to strong sunlight. Otherwise, they may be deformed or cannot function correctly.

游玩後把發射開關置“OFF”。

Set the shooting switch to OFF after use.

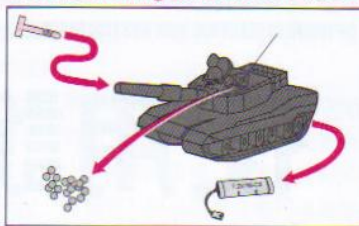

控制後把主開關置“OFF”

① 發射開關置“OFF”

② 插上保護蓋

③ 把BB炮彈取出(翻轉車身，把炮彈取出)

④ 拆下電池(否則由于自然放電會引起漏液)。Set the main switch to OFF after playing.

① Set the shooting switch to OFF.

② Insert the protective cap into the gun muzzle.

③ Remove the BB bullets. (Turn the tank upside down and pour out the BB bullets.)

④ Remove the batteries. (Otherwise, the batteries may discharge by themselves and cause leakage.)

注意：任何時候都不要窺視發射口

Caution: Never look into the gun muzzle.



不管裏面是否有炮彈，不可窺視發射口，以免傷到眼睛，如無線電波不佳時，由于誤操作可能會發射出來，非常危險。

To protect your eyes, never try to look into the gun muzzle, whether there is bullet inside or not. Please also note that accidental shooting may be triggered when the radio signal is poor.

注意：不可在人和汽車橫過的地方發射

Caution: Never shoot in a place where there are people or cars passing by.

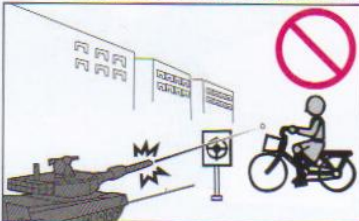

在這些場所發射有可能意外傷到人，決不可發射。

If there are other people or cars passing by, shooting may cause danger to them. Do not shoot in such places.

注意：不可把手伸入車輪和履帶

Caution: Do not put hands into the wheels or the caterpillars.

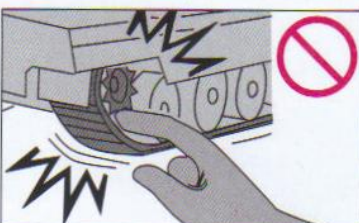

不可把手伸入車輪和履帶以免誤夾傷，小孩需特別小心，當拿坦克時不可拿住車輪以免由于誤操作而受傷。

Do not put the hands into the wheels or the caterpillars to avoid hurts. Do not touch the wheels or the caterpillars when holding the tank to avoid hurts by misoperation.

警告 Warning
注意 Caution

若無視裏面的警告，自行進行錯誤操作，會發生誤傷和誘發故障。絕對要遵守各注意事項。
Hurts or malfunctions may be caused if the cautions are neglected. Please abide by all requirements.

注意！ 本戰車用于室內競技，不可按下述在戶外使用。 **Caution: This battle tank is for indoor use only! Please avoid the following misuses.**

該戰車制作精密，需小心，不可亂碰撞；不可讓灰塵、小石等侵入車子內部和齒輪。(遙控器也同樣) (否則即使在保修期間也由顧客負擔！)
This tank is a precisely-made product and should be used with care. Avoid bumping or dust or sand or stone entering the body or the wheels. (The same requirements for the remote controller) (Otherwise, all related expenditure would be born by the user!)



車子跌落、碰撞等強烈的衝擊會造成故障。
Violent shocks caused by fall or bump may lead to malfunction.



不可在有積水的地方行走(遙控器也不可弄濕)
Do not play the tank in a place where it could easily get wetted. (The remote controller should also be kept dry.)



戶外的砂地、凹凸不平處，灰塵多的地方也不行行走。
Do not play the tank on sands or other uneven surfaces or in a place with too much dust.



不可在草地、沼澤地等阻力大的地方行走。
Do not play the tank on lawn or other places that may cause excessive resistance.



投入口不可裝入指定BB彈以外物品。
Do not put articles other than the specified BB bullets into the bullet hatch.

注意 Caution



使用工具時注意安全
Keep yourself safe when using tools.

- 需另購的物品(遙控器電池) Articles to be purchased (controller's batteries)
- AA電池8粒(用于遙控器) 8X AA Batteries (For controller)

電池的注意事項 Battery-related caution

破損 Broken



不可使用破損電池，以免發生短路危險。
Do not use broken batteries to avoid short circuit.

發射時戴上護目鏡，確保安全。
Please wear goggles to ensure safe play.



套件內容 Set content

注意

安裝附屬零件前要檢查是否正確操作(見3P 4P 5P 6P 7P)

Caution: Check to make sure the tank functions correctly before installation of the accessories. (See P3, P4, P5, P6, P7)

遙控器 Remote controller

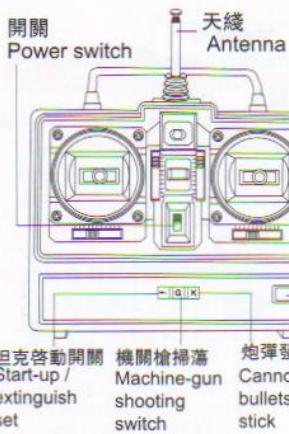

開關 Power switch
天線 Antenna
坦克啟動開關 Start-up / extinguish set
機關槍掃蕩 Machine-gun shooting switch
炮彈發射 Cannonball (BB bullets) shoot joy stick
晶體插座 Crystal socket

貼紙和人物裝于盒子裏
The seals and the figure are packed in the box.



保護蓋 Protective cap

保管時務必蓋上保護蓋，發射時取下
(Make sure the cap is always set on the muzzle except when shooting.)

置物架 Runner frame

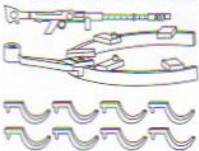

Aerosol 煙霧劑

充電器 Transformer

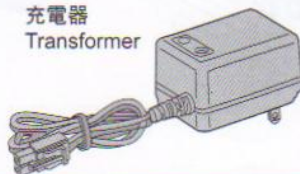

充電電池 Rechargeable battery

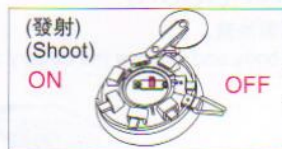
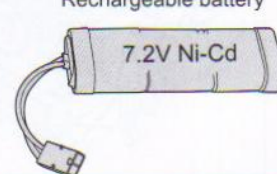

炮身 Gun barrel

炮塔 Turret

天線 Antenna

煙霧出口 Exit of smoking



坦克長 Tank operator

BB彈 BB bullet



靶子 Target

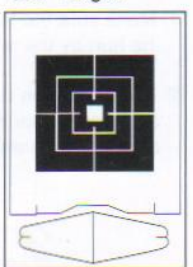

貼紙 Seal



萬一無法正確操作，請聯系售後服務部或所購買的商店。

If you find the tank cannot function properly, please contact our after-sales service center or the shop that sold it to you.

注意：裝上了零件的商品不能更換，這時被認作是修理。

Caution: It may be difficult for us to replace for the user a tank that has already been installed with the accessories. Only repair service will be available for such request.

警告 Warning

若正負極接反，會引起漏液和故障，要小心。

If the connection is made the opposite, battery leakage or device malfunction may be caused.

1 電池 (遙控器) BATTERY (CONTROLLER)

② 正確裝好電池。Load in the battery correctly.

- ① 按下電池蓋的PUSH，把它拆下。(把開關撥在OFF)
- Press down the PUSH on the battery cover and remove it at the same time. (Make sure the switch is on OFF position.)

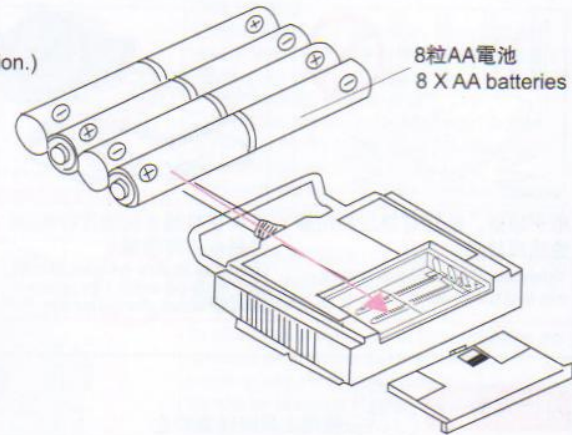
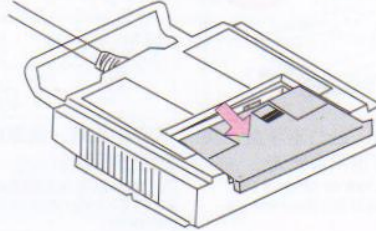

- ③ 關上電池蓋 Replace the cover.

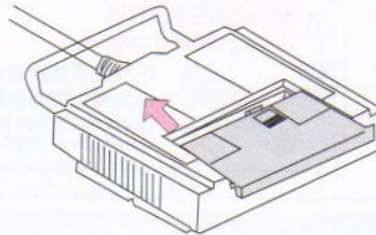

注意：打開車體開關時務必先把遙控器開關置于ON，關掉開關時先將車體開關置于OFF，若次序搞錯會引起坦克突然衝出去。

Caution: When turning on power, the remote controller should be first turned ON. When turning off power, the tank should be first turned OFF. If the sequence is not followed, the tank may suddenly rush forward.

2 電池 (車體) BATTERY (TANK)

- ① 撥一撥車體背後的蓋子壓件，打開電池蓋。
- Pull the cover fastener under the body and remove the battery cover.

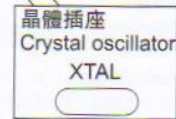
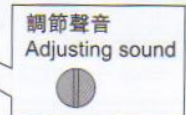
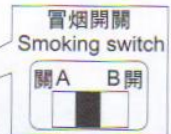

電池蓋
Battery cover

蓋子壓件
Cover fastener

警告 Warnings

- 注意手不要被電池的端子割傷。
- 不可把鹼性電池和錳電池混用，以免漏液。

- Make sure the hands will not be hurt by the terminals of the battery.
- Do not mix the use of alkaline and manganese batteries to avoid leakage and burn hurt.

- 裝入電池。
- Load in the battery.

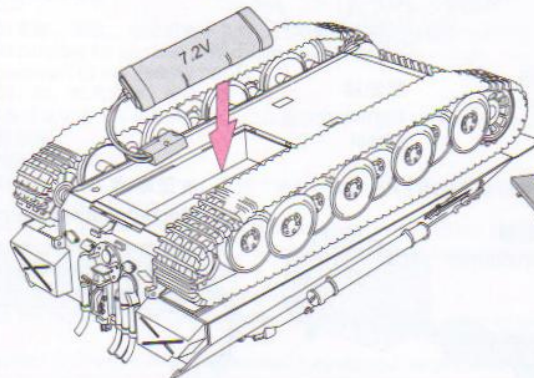

- 在撥一撥蓋子壓件的同時，把爪子插好。
- Pull the cover fastener and insert the claws properly to replace the cover.

爪子
Claws

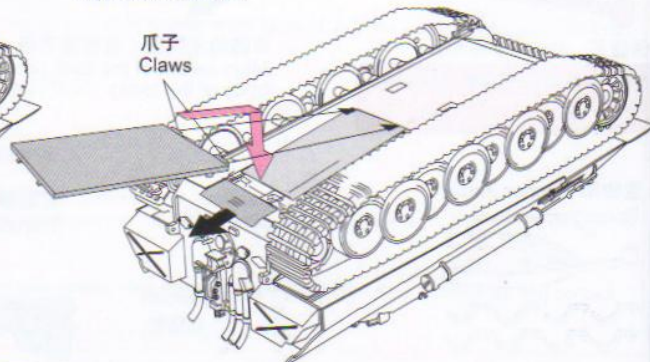

⚠ 注意 Cautions:

- 打開開關要從遙控器先打開，關閉開關時則從車體先關，否則可能車子無法行走或突然衝出去。
- 若遙控器和車子太接近，天線接觸到其他物品，可能會無法運作或出現錯誤操作。
- 在室內電波的到達距離會縮短一些。
- 1米以內的近距離需把遙控器的天線縮短些。
- 行走時撞到物體炮身會彎曲不能發射，附屬零件可能破損，要小心。
- When turning on power, the remote controller should be first turned ON. When turning off power, the tank should be first turned OFF. Otherwise, the tank may not function normally and may suddenly rush forward.
- If the remote controller is too close to the tank or its antenna touches other articles, the tank may not be properly controlled.
- If the tank is used indoors, controlling range of radio signals may be shortened.
- If the tank is within 1m away from the controller, please shorten the antenna.
- If the gun hits something when moving, it may become bended and unable to shoot.

⚠ 注意 Cautions:

- 在阻力比較大的地方和凹凸不平的地方（履帶鬆脫、被東西纏住時）不可強行按下行走操縱杆使車子行走，否則基盤和馬達會發生破壞。
- 如果履帶鬆脫時仍強行操作，可能會弄斷它，要先把它裝好後，再在上述地方之外的場所行走。
- Do not try to press the running joy stick when the tank is on an even surface or a surface with excessive resistance, or when the caterpillars get loose or entangled with
- In the event that the caterpillar gets loose, any forced movement may cause it to break. Correctly reassemble the caterpillar before you try to operate it.

3 行走的控制 HOW TO CONTROL RUNNING

- 打開開關時先開遙控器再開車體（關閉開關時則相反）

First turn on the remote controller then the tank when turning on power. (Sequence for turning off power is the opposite.)

遙控器各個部分的名稱

Controller Parts Identification

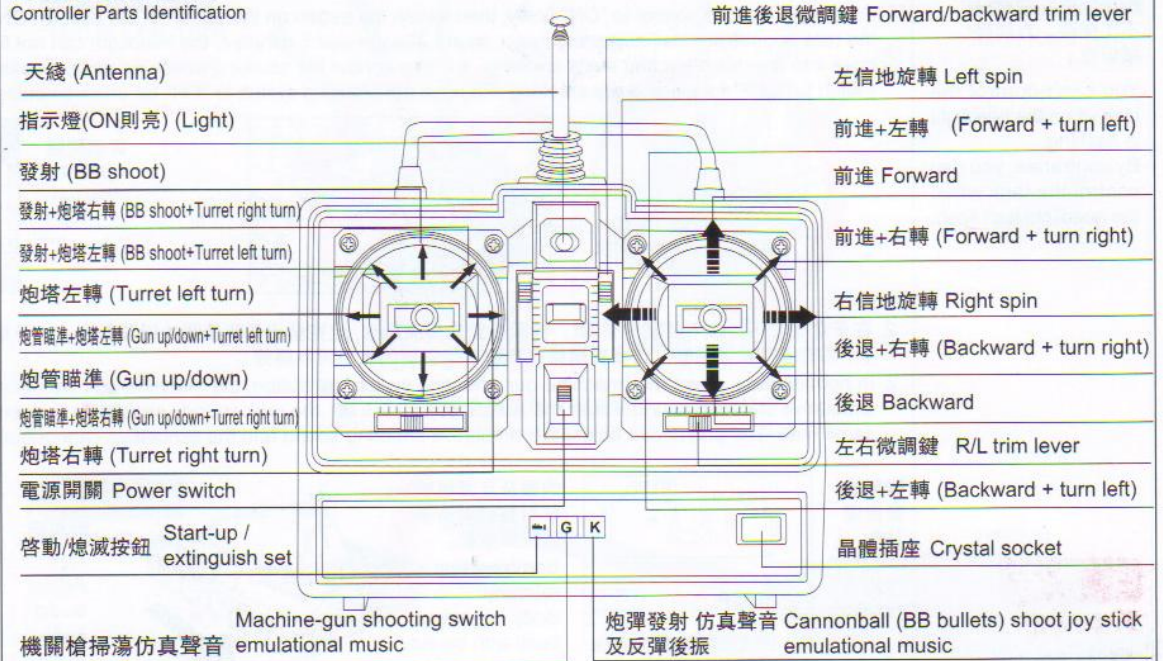

驅動功能全比例無級調速

Full scale drive function limitless timing

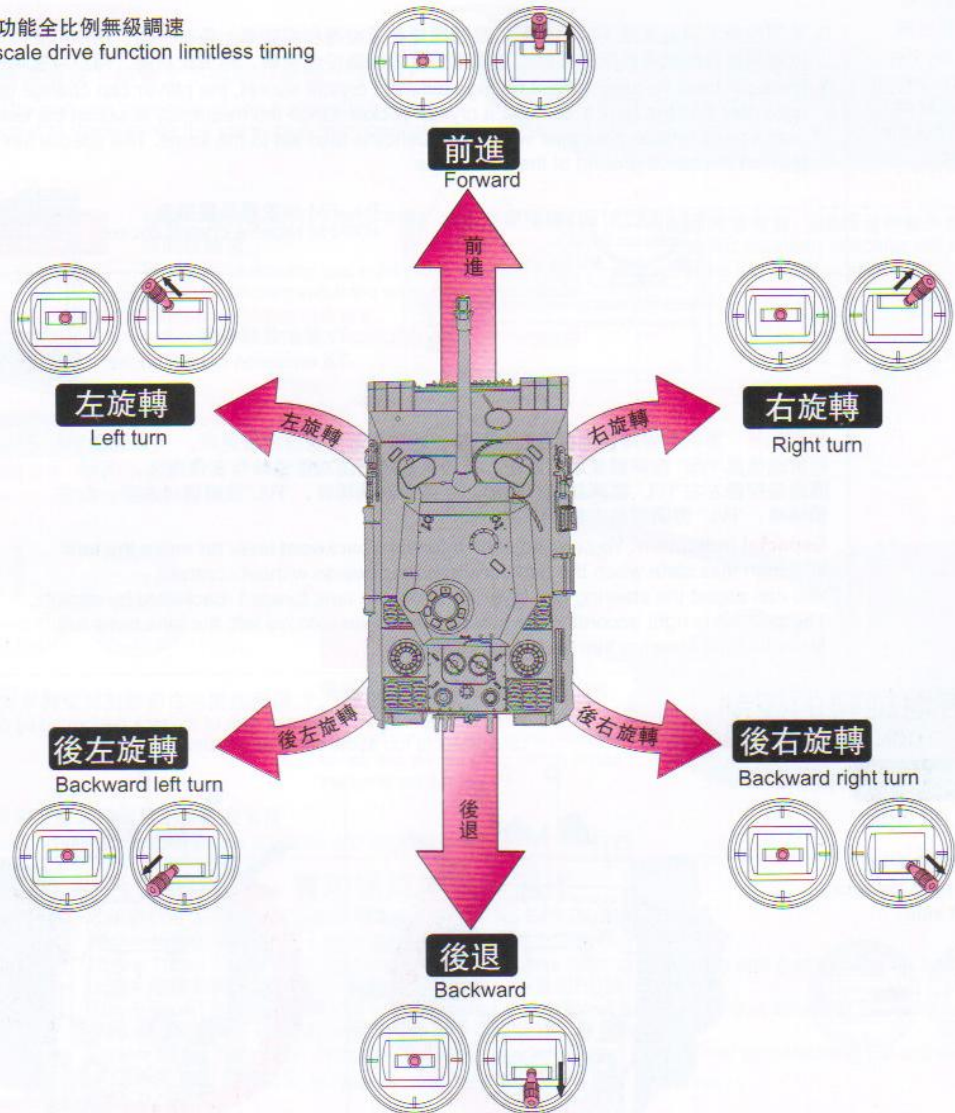



警告
Warning





當前燈閃爍時,不能控制坦克。需前燈不閃爍時,方能操縱坦克。

You can't control the tank when the headlight is flashing. By contraries, you can control the tank when the headlight isn't flash.

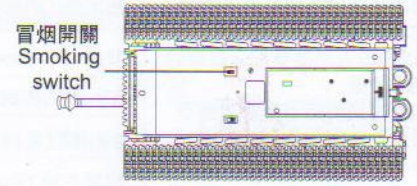
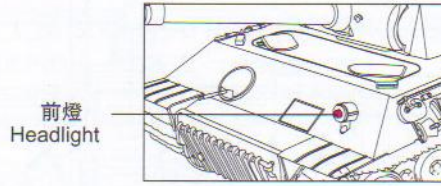
4 操作描述 HOW TO OPERATE

1. 先打開遙控器開關,再打開坦克電源開關,這時坦克前燈閃爍。按下啟動鍵 , 坦克發出仿真馬達啟動聲。過5秒後,坦克前燈不再閃爍(前燈亮但不閃爍),這時才可進入操作狀態並放出煙霧。煙霧可通過開關控制。若不想放出煙霧,把煙霧開關撥到“OFF”的位置。若要放出煙霧,把開關撥到“ON”的位置即可。
1. Switch the remote control to "ON" firstly, then switch the button on the button of the tank to "ON". Press the "start-up"  button, the tank sounds simulative starting motor sound. Please wait 5 minutes, the headlight can not flare (but it can light), so the tank goes into operate state and emits smoking. You can control the smoking switch to emits smoking or not. Remove the smoking switch to "OFF" for close emits smoking. Remove the smoking switch to "ON" for emits smoking.



2. 在正常狀態下,按下機關槍聲 , 機關槍警告燈亮起來,坦克發出仿真機關槍掃蕩聲音。按下炮彈發射鍵 , 坦克發出仿真炮彈聲音,同時坦克反彈振動。仿真機關槍聲和仿真炮彈聲的大小可以調節。
2. In normal state, press the "machine-gun shooting switch"  button, the machine-gun indicator will light up, the tank sounds simulative shooting sound. Press the BB shoot joy stick , the tank sounds simulative cannonball sound and it backwards at the same time. The player can adjust the simulative shooting sound and the simulative cannonball sound.

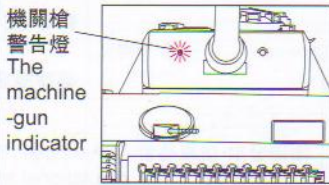

警告
Warning

更換坦克的晶體時,捏住晶體的頻率不幹膠,把晶體撥出來。Replace the crystal socket, nip the paster of crystal socket on the tank, pull out the crystal socket.

3. 不同的頻率通過更換不同的晶體。晶體插座在遙控器和坦克車上各有一個,用戶可更換不同的晶體,當用戶選中某頻率後,該坦克祇能接受與該頻率匹配的晶體。這樣遙控器才能遙控坦克車,利用此功能,用戶可在同一場地同時操作多輛坦克。
3. Pass different frequency must change different crystal socket, the player can change different crystal socket. The remote controller and the tank both have a crystal socket. Once the frequency is set on the tank, the tank can only accept control signals sent from a remote controller whose frequency is also set to the same. The special function makes it possible for some tanks to play on the same ground at the same time.



特別注意: 當沒有操縱前進後退控制杆時,坦克車還是前進或後退時,可以通過調節前進後退“F/B”微調鍵使坦克靜止。當坦克直綫前進或後退時存在偏轉時,可以通過遙控器左右“R/L”微調鍵進行調節。坦克向右偏轉時,“R/L”微調鍵向左移;向左偏轉時,“R/L”微調鍵向右移。

Especial indication: You can adjust the forward/backward lever for make the tank in action less state when the tank forwards /backwards without control it. You can adjust the steering trim lever for make the tank forward /backward by straight. The tank turns right according the steering trim lever remove left; the tank turns left according the steering trim lever remove right.

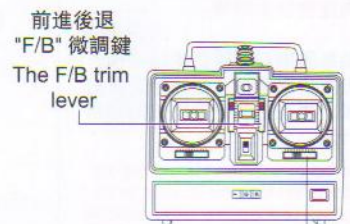

5 超信地旋轉的控制

HOW TO CONTROL SUPER SPINS

何謂“超信地旋轉”?即通過使左右履帶逆向旋轉來使車體的方向改變的旋轉。What is "Super Spin"? A kind of spin of the tank performed by controlling the two caterpillars to run at the opposite directions.

左超信地旋轉

Super Left Spin

把右操縱杆向左撥。Turn the right joy stick to the left side.

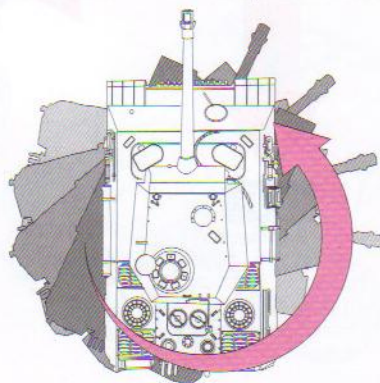
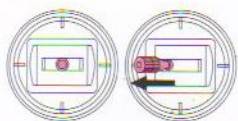

右超信地旋轉

Super Right Spin

把右操縱杆向右撥。Turn the right joy stick to the right side.

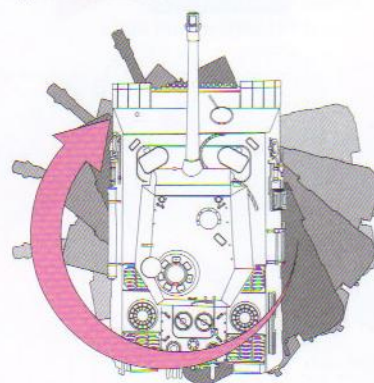
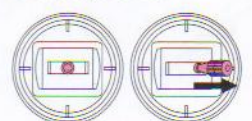

警告 Warning

當出現幹擾電波，電波狀況變差時，有可能因錯誤控制而造成突然發射，在這種情況下不可發射BB彈或行走。(炮塔內部的開關置OFF，發射口蓋上保護蓋)

When control is interfered by other radio waves or the control signals are not strong enough, the tank may not act correctly and may shoot accidentally. Immediately stop tank running and shooting in such circumstances. (Remember to turn off the switch inside the turret and put the protective cap onto the gun muzzle.)

注意 Caution

當炮塔旋轉至後方時離合器會運作使之不會旋轉。這是正常的，若強行使它旋轉則會引起故障。

Whenever the turret turns to its limit at the back of the tank, the clutch functions and prevents further turning of the turret. It's normal phenomenon. Do not try to force the turret to turn any further to avoid damage.

注意 Caution

- 這個RC坦克規範的最大射程約25米，根據發射時的情況(炮身仰角和風速等)而變化。

The maximum shooting range of the RC tank is 25m, which may differ according to actual shooting conditions, such as vertical angle of the gun and wind speed.

警告 Warning

- 發射時要注意周圍是否安全
- 發射時周圍的人要戴護目鏡
- 有時候以為彈全部發射完了，但在車體內部有可能剩餘子彈。若無意中撞擊而發射會造成危險，要小心。
- 使用後把BB彈發射口裝上保護蓋，車子主開關和發射開關都置OFF，取出BB彈和電池，保存于安全之處。

- Shooting can only be carried out in a safe environment.
- People in the shooting spot should all wear goggles.
- Sometimes bullet remains inside the tank but you think no bullet remains. It's dangerous because the bullet may be shot out accidentally.
- After use, remember to put the protective cap onto the gun muzzle, turn off the main switch and the shooting switch on the tank, remove BB bullets and batteries, and store them in a safe place.

注意 Caution

發射時炮塔要處在水平。Turret should stay horizontal when shooting.

在發射系統的構造上，炮塔部分的左側朝下時，或者炮塔後部朝下則BB彈無法給彈，因而無法發射。

According to the design of the turret, if the left side or the back side of the turret is lower than their counter sides, bullets can not be loaded and shooting becomes impossible.

6 炮塔部分的控制 HOW TO CONTROL TURRET

炮塔左旋轉

Turret Left Turn

按下炮塔左旋轉控制杆
Press the joy stick for turret to turn left.

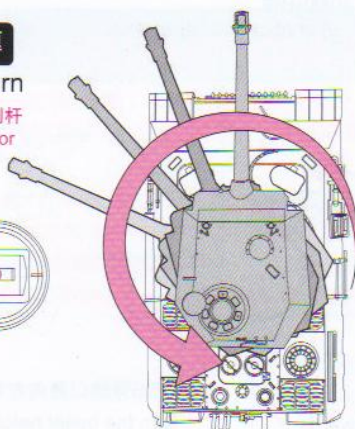
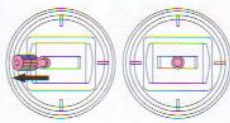

炮塔右旋轉

Turret Right Turn

按下炮塔右旋轉控制杆
Press the joy stick for turret to turn right.

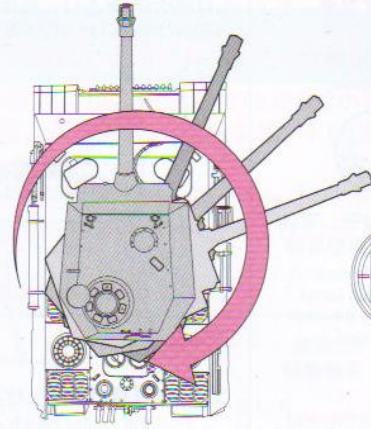
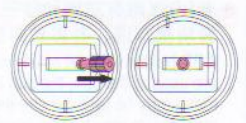

※旋轉至這裏離合器就運作，無法再轉了。

※ The clutch functions whenever the turret reaches this limit and it cannot turn any further.

炮身上下

Gun Up/Down

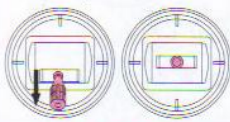

按下炮管上下控制杆
Press the GUN UP/DOWN joy stick.

※若連續按下炮管上下控制杆就能上下變化。

※ The gun can continuously and alternately move up and down when the joy stick is kept pressed.

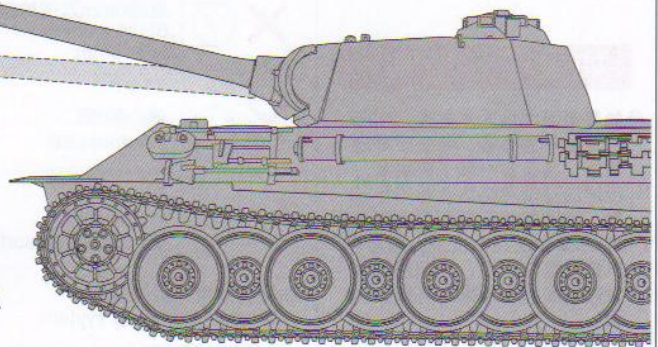

注意 Caution

注意

發射子彈時參照7P⑦裝好子彈，把發射開關置ON 拆開保護蓋。
To prepare for shooting, load in BB bullets as shown in 7P⑦, turn on the shooting switch and remove the protective cap.

- 如果裝着保護蓋時發射BB彈則內部機構會損壞。
Shooting with protective cap on the gun muzzle may cause damages to the inner mechanism.



※在即將發射前，BB彈發射警告燈會亮起來
※ The BB shooting indicator will light up right before the bullet is shot out.

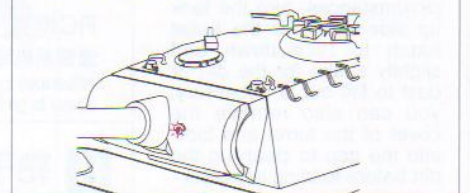

BB發射

發射時按下“BB發射控制杆”

To shoot, press the BB SHOOT joy stick.

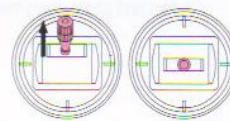

按下發射控制杆
Press BB SHOOT joy stick.

注意 Caution

電源開關和炮塔內發射開關沒有打開就無法發射(7P⑦)
The gun cannot shoot when the main switch and the shooting switch inside the turret are set to OFF.

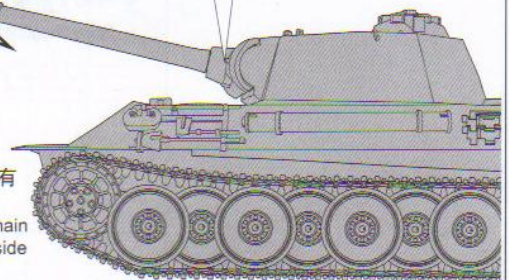

※連續按下控制杆則發射運作會重複

※ Shooting continues when the joy stick are kept pressed.

推薦: 組合各種操作，實現逼真的戰術運作

Suggestion: Operations can be combined to simulate actual tank moves.

- 例: 行走 + 炮塔旋轉 + 上下 = 邊走邊炮塔旋轉、炮身上下動作
Run + Turret Turn + Gun Up/Down = The tank runs with turret turning and gun moving up and down
- Examples 行走 + 炮塔旋轉 + BB發射 = 邊走邊炮塔旋轉、并發射BB彈
Run + Turret Turn + BB Shoot = The tank runs with turret turning and gun shooting BB bullets.
- 旋轉 + 炮塔旋轉 + BB發射 = 變方向的同時炮塔旋轉，發射BB彈
Turn + Turret Turn + BB Shoot = The tank turns with turret turning and gun shooting BB bullets.

※除此之外你可以想出其他各種變化 ※ You can think out other new combinations.

注意 Caution 複合動作會使電池的消耗增加 Combinations consume more battery power.

⚠ 注意 Caution

- 使用過的BB彈沾上了灰塵，不可再用
Once shot out, the BB bullet becomes dirty and not suitable for reuse.



- 若BB彈附有灰塵和砂子，可能會堵塞彈道，並導致內部故障
If BB bullets with dirt or tiny sand on are used in the gun, the gun barrel may easily be blocked and the inner mechanism may be damaged.

- 不可強行裝入子彈，否則會發生故障
Improper loading of bullets may lead to malfunction.

- 使用0.2g以上的重彈時，子彈飛得不會太遠
If the bullets used weigh over 0.2g, they won't be shot far enough.

如果子彈堵塞

- 如果彈匣中進入灰塵等，BB彈的流動不會順暢，無法很好地發射，甚至會引起子彈堵塞。出現這種情況時要立即停止發射，把彈匣朝下輕輕搖動戰車，把BB彈和灰塵倒出來，甚至可以把炮塔蓋拆下，從間隙吹入氣體把灰塵吹出來後再裝入BB彈。

If dirt or dust gets into the bullet hatch, the rolling of the bullets may be disturbed, making shooting difficult or even impossible. In such circumstances, turn the tank up side down for the bullet hatch to face down and slightly shake for the dirt or dust to fall out. If necessary, you can also remove the cover of the turret and blow into the gap to clean up the dirt before loading in bullets

7 BB彈的裝填 HOW TO LOAD BB BULLETS

1. 打開BB彈投入口，約投入40顆BB彈
Open the bullet hatch and put in about 40 BB bullets.

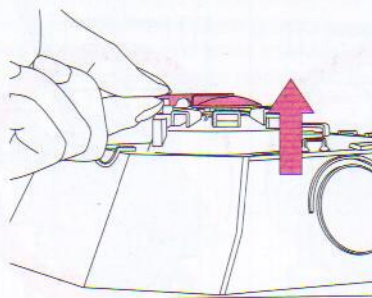

- ① 把BB彈槍口蓋向上拉。
Pull the bullet hatch upwards.

使用下列不良炮彈會損壞內部機件
Use of the following bad bullets may lead to internal damages.

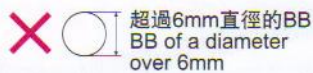

超過6mm直徑的BB
BB of a diameter over 6mm



偏心的BB
Eccentric BB

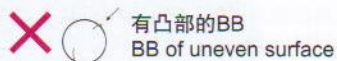

有凸部的BB
BB of uneven surface

- ※ 彈道改良系統的說明
※ briefing of hop-up system

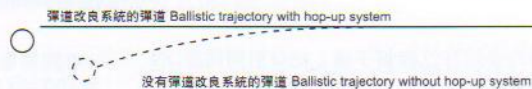

RC坦克上帶有彈道改良系統 The RC tank is equipped with hop-up system.

這個系統通過一定的空氣壓力，在發射出去的BB彈上加上強烈的後旋轉，這樣就產生上升力使子彈盡量向遠方發射。Influenced by the system, the shot out BB bullet will forcefully spin back while running forward at high speed, generating climbing power to go further ahead.

- 如下圖所示，飛行距離大幅度提高
Flying distance becomes much longer, as the picture shows.

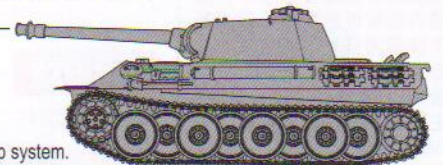

8 靶子的安裝 HOW TO SET UP TARGET

- 向靶子射擊，使發射更具有樂趣
Enjoy shooting using the attached target.

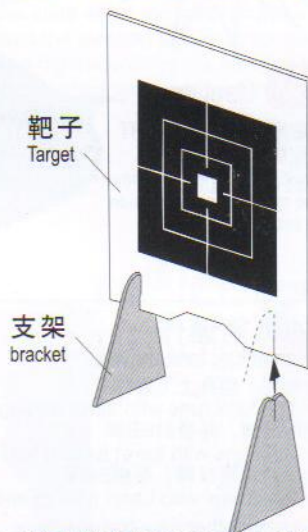

- 把靶子對準支架的缺口，如圖插好
Firmly insert the target to the holding gaps on the supports.

- 注意 Caution
無需螺絲，牢固地插好
No screws needed for the setup.

從戰車上向靶子瞄準，並擊倒它
Aim and shoot down the target by controlling the tank.

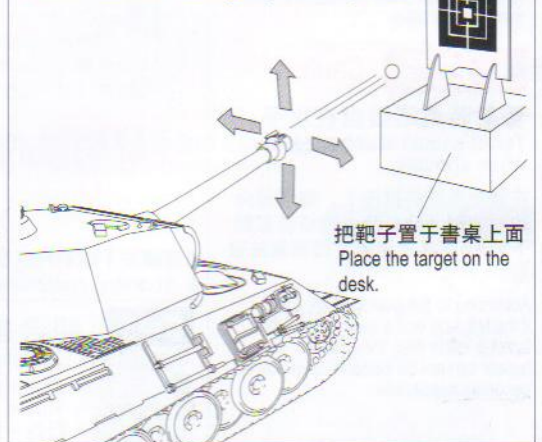

把靶子置于書桌上
Place the target on the desk.

- 要點: Points:
要正對靶心射擊，則要從戰車的正後方瞄準，使炮身在動作的同時找到感覺進行發射
Aim at the bull's eye from the back of the tank before shooting. Fire during the aiming moves of the gun to shot down the target.

! ESPECIAL INDICATION 特別提示

冒烟裝置的使用方法 OPERATING INSTRUCTIONS ABOUT SMOKING SET

本坦克車出廠時，已添進少許烟霧劑。在第一次使用前，必須添加烟霧劑2-3毫升。可以使用累計時間約2小時左右。（但有時使用不到2小時，聞有燒焦味時。這表示烟霧劑快使用完，必須馬上添加烟霧劑，否則會損壞冒烟裝置。）以後每次使用累計超過2小時，都必須再添加5-6毫升烟霧劑。

There is litter aerosol in tank at factory. You must add 2-3 ml. aerosol for the first time use, the 2-3 ml. aerosol can use about 2 hours. (This indicates the aerosol have exhaust when you smell single smell within 2 hours. So you must add the the aerosol to avoid malfunction of the smoking set).

You must add 5-6 ml. aerosol for use about 2 hours every time except the first time use.

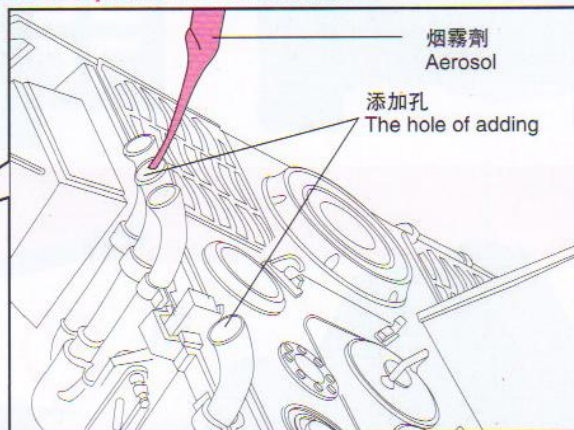
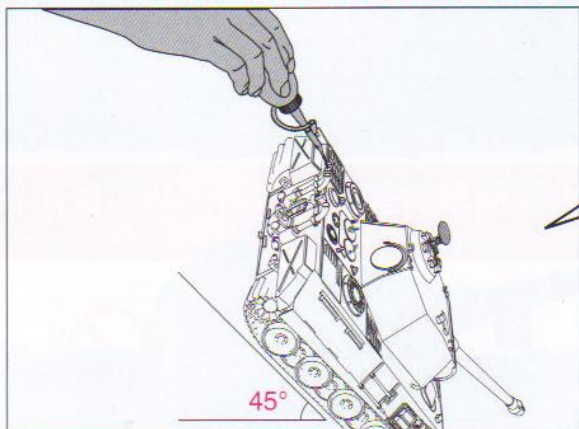

注意
Caution

在添加烟霧劑過程中必須使坦克傾斜45度。
Ensure the tank tilt to one side 45 degree while increase the aerosol

9 附屬零件的安裝 HOW TO INSTALL ACCESSORIES

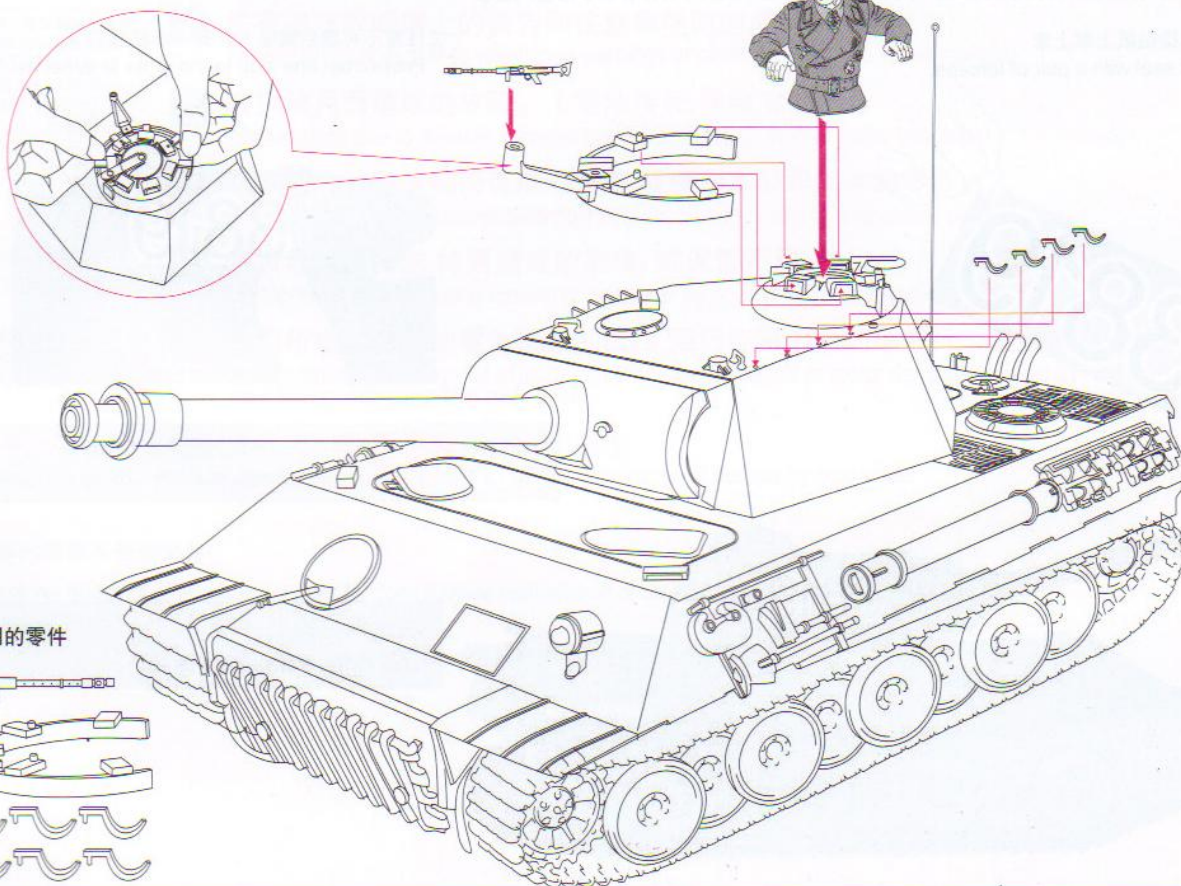

四面圖 Views of The Tank

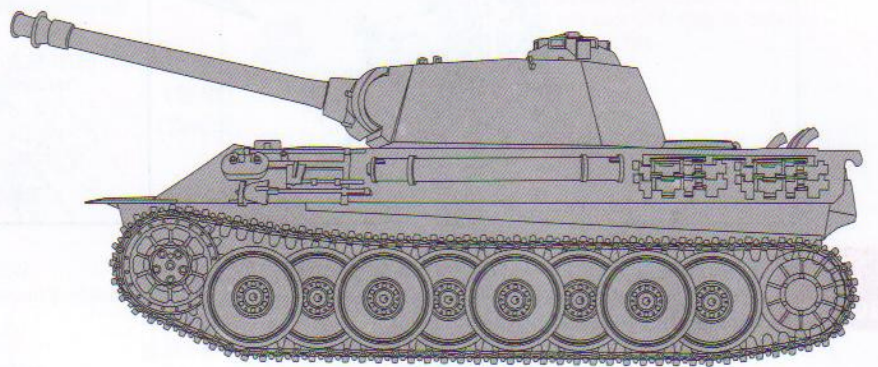
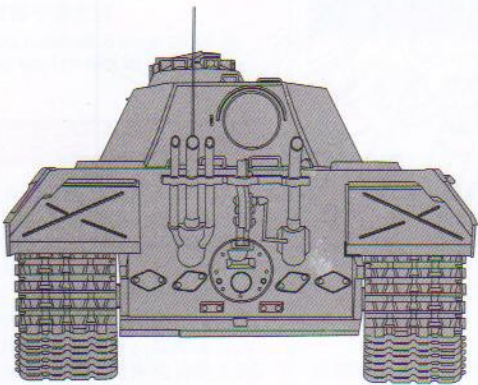
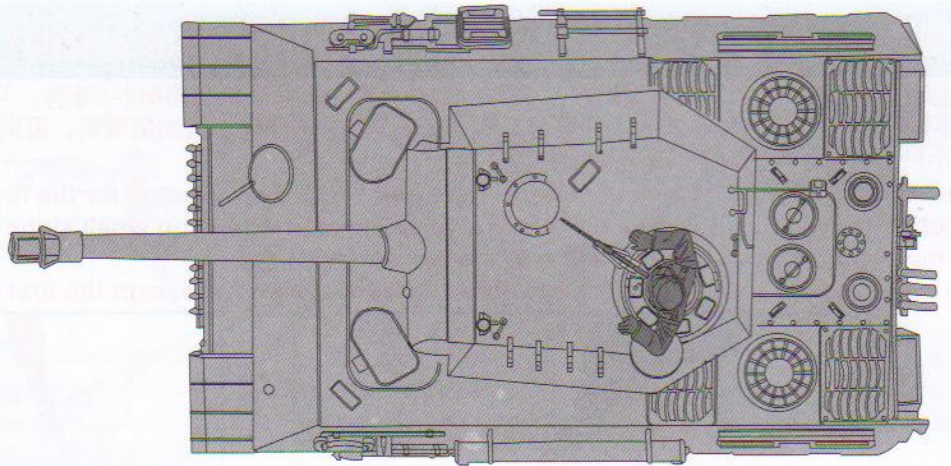
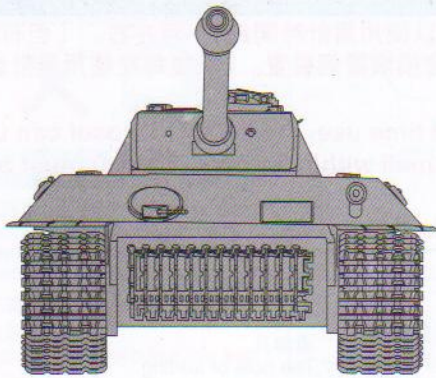

10 部隊番號貼紙的貼法 HOW TO STICK MARK SEALS

① 把要貼的標志從貼紙上取上來
Take the proper seal with a pair of forceps.



② 注意不可讓空氣進入，從一端壓緊它
Press from one side to the other to expel air.

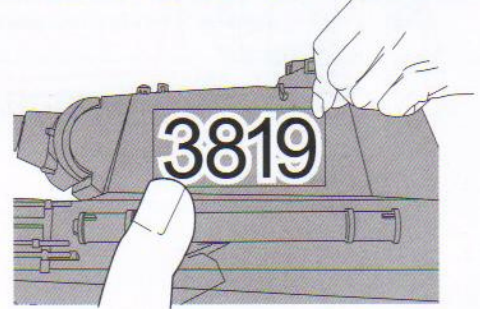

警告
Warning:

● 使用劃刀時注意不可誤傷。
Be careful when using the cutter knife.

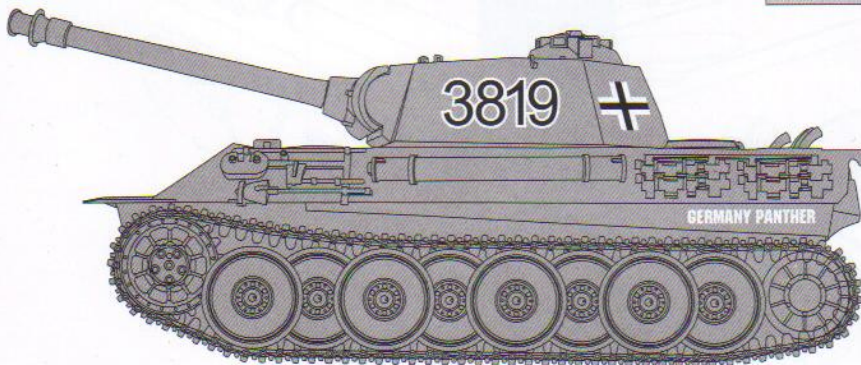

右邊跟左邊貼一樣。
The right side like the left.

● 置物架零件
Runner frame

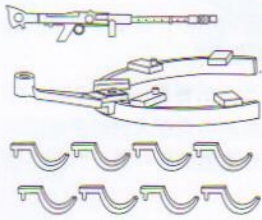

● 貼紙
Seals



● 坦克長
Tank operator



修理時須知：以下情况即使是保修期間也要付款

Note: Repair services to damages caused by the following reasons are to be charged, whether within the term of quality guarantee or not.



1 掉落、強烈撞擊造成的故障。
Accidental fall or strong bump, which leads to tank or controller damages.

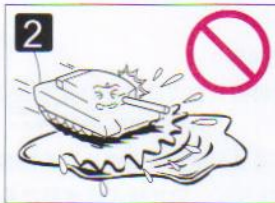

2 在積水和潮濕處行走，被水弄濕（包括遙控器）造成的故障。
The tank (or the remote controller) is wetted when running in a wet place, which leads to malfunctions or breaks.



3 在戶外泥地、沙地、凹凸不平處、灰塵多之處行走造成的故障。
The tank runs in a place with too much sand, mud, dirt, or on an even surface, which leads to malfunctions or breaks.

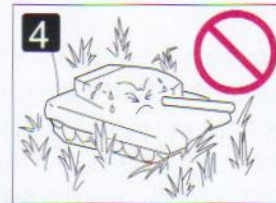

4 在地毯、草地等阻力大的地方行走而造成的故障。
The tank runs on carpet, lawn or other places with excessive resistance, which leads to malfunctions or breaks.



5 在BB彈投入口放入指定BB彈以外物品而堵塞造成的故障。
Articles other than the specified BB bullets are put into the bullet hatch, which leads to inner blockage.

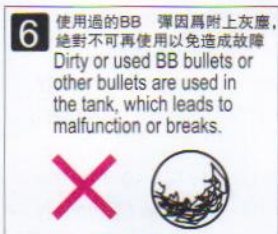

6 使用過的BB彈因為附上灰塵，絕對不可再使用以免造成故障。
Dirty or used BB bullets or other bullets are used in the tank, which leads to malfunction or breaks.
使用污染的BB彈，用過的BB彈和指定以外的BB彈而造成的故障。
BB bullets that have been used may get dirt on them and cannot be reused to avoid damages to the tank.

7 沒有遵守說明書上的警告和注意事項而造成的故障。
Other malfunctions due to violation of warnings or cautions described in this manual.

8 錯誤使用而造成的故障。（電池接反，弄濕，碰撞等）
Malfunctions due to misuses (reverse battery connection, wetted parts, or bumps).

9 不當的分解和改造而造成的故障，或使用本公司以外的零件。
Malfunctions due to improper assembly or restructuring or use of unspecified parts.

10 購買後由于輸送，掉落造成的故障，或保管不周。
Malfunctions caused during moving or by falls or by poor storage condition.

11 使用所指定以外的電池造成的故障，強行在阻力大的地方行走而損傷主板和馬達。
Malfunctions caused by use of unspecified batteries. Chassis or motor damages caused by running over places with excessive resistance.

12 其它保證規定之外的故障和損傷。
Other malfunctions or breaks not within the range of our quality guarantee.

※ 改造或分解的商品不受理維修

The manufacturer does not offer repair services for commodities restructured or disassembled by the user.

GERMANY PANTHER 德國豹戰車簡介



即使是在重視使用電子裝備的信息戰的今天，戰場上互相追求高科技兵器的威力，但陸地戰爭起到主導作用的依然是坦克，它具有壓倒性的強大裝備，具有疾風怒濤般的機動力，具有令人畏懼的大炮毀滅力。坦克在全世界愛好者的心中，是夢寐以求的理想戰鬥機器。

過去，有數以千計的仿真坦克被製造出來，受到全球幾代人的喜愛；有木制的、塑料的、帶馬達的、有線式的、無線控制的等等。這不計其數的坦克使人們的夢想得以實現。今天，在這輝煌的歷史中，提出了“最新的，具有紀念意義的新一頁！”的口號，作為研制開發的指南。

這種結果就實現了超逼真的外觀。與1/35、1/60這兩種原來的模式相比，1/16這種模式遠遠地超越了它們。它實現了大型化，在各細節上也能忠實地模仿原來的樣式，而且1/16這種尺寸是公認的國際規格。由於與其他多數的車模尺寸相同，它們與本品同時展出可以襯托出“德國豹”戰車的存在感和逼真形象。

第1個銷售的賣點是它的行走性能，作為現代的最新型戰車，“德國豹”動作敏捷，能夠挑戰遙控車的極限。前進、後退、左轉和右轉就不用說了，作為坦克特徵的履帶動作、信地旋回、超信地旋回也可以實現，坦克使用全比例遙控，前進後退速度可自由控制，讓我們領略各種方式行走的樂趣。

第2個銷售的賣點是炮塔能夠左右旋轉、炮身上下運動。這樣，就與實物一樣能夠準確地對準目標而不會漏掉！主炮是正式的電動炮（具有彈道改良系統）BB彈的射擊距離約25米，而且與實物同樣是自動裝填式的。

第3個銷售賣點是它的仿真聲、啓動點火馬達聲、發動機聲、發炮聲及發炮振動、機關機聲、發動機熄滅聲及冒煙功能，使操作者身臨其境。

當BB彈發射時，“德國豹”戰車的“直接瞄準孔”上安裝的紅色“BB彈發射警告燈”就會亮起來，以防止無意間誤發射。同時，讓坦克像活物一樣具有表情(好像瞄準獵物的獵手一樣)！

“前進”“瞄準”“發射”實物戰車具有動作都能夠實現，這就是最新高科技研制的戰車的精髓！

色調和圖案也能逼真地再現實物形狀。迷彩噴塗和車體主要部件噴塗完成的機體和控制器使每個人都可欣賞到行走和BB彈發射的妙趣。還有安裝上了坦克長；今後陸續推出的各樣新款配件都將使遊戲更具情趣。

新感覺的遙控器操作非常方便，所以邊行走邊轉向和發射BB彈的複合動作也會十分方便！電源則使用充電電池，控制器使用8粒AA電池。可實現連續30分鐘的行走，由於可以更換不同的晶體，可以實現多臺戰車同時行走而不會互相幹擾。這樣你可以和其他人或者朋友各自拿出自己最得意的戰車來比賽，甚至進行戰鬥！

“創造、技術、品質！”是本公司面向21世紀的三個口號，而“1/16 RC戰車系列”則完全和以上口號相吻合，本公司將致力於為車迷着想，為廣大愛好者做出新貢獻。

Introduction of RC Battle Tank GERMANY PANTHER

Today, while modern war depends more and more on information and high-tech electronic equipment and electronic weapons, tanks still play a key role in ground wars. Well known for strong driving power and mass destructive gun, they are ideal weapon for military fans around the world.

During the past decades thousands of simulated tanks have been developed and been favoured by generations of people worldwide. Technology is gradually developed, starting from the first wood-made mold to motorized one then to wire-controlled one. Finally here come the wireless controlled molds. Now it is time for us to seek another breakthrough in the history of tank molds.

As a result of our research work, a whole new model, RC battle tank GERMANY PANTHER (1/16 scale) with vivid look, has made its debut on the market. Compared with the former models of 1/35 and 1/60 scales, it is much larger and simulates more details of a real tank. Besides, the commonly accepted scale of 1/16 makes it more real and outstanding if displayed together with other models of the same size.

The first sales point is its excellent maneuvering performance. As the latest modern tank, it has high agility and exceeds the limits of moves of traditional remote controlled cars. Except normal moves, such as forward run, backward run, left turn, and right turn, it can perform spin stunt and super spin stunt with caterpillars, which are unique and characteristic moves of a tank. Because the tank uses full scale R/C function, speed forward and speed backward can be controlled allodially.

The second sales point is that its turret can turn sideways and the gun can move up and down, imitating actual aiming acts of a tank. The powerful motor air gun (with hop-up system) can shoot BB bullets as far as 25m. What's more, the bullets can be loaded automatically, just like a real tank.

The third sales point is that its emulational music、simulative motor start-up sound、engine sound、machine-gun sound and cannonball sound, and smoking function, let the manipulator is personally on the scene.

There is a red indicator for BB bullet shooting near the direct aiming hole on the battle tank. It will light up before shooting, warning people of the shooting and making the tank more like a real hunter.

"Run forward! Aim! Shoot!" All these acts of a real battle tank can be performed by this simulated tank.

The color and pattern on the body of the model also perfectly resemble a real tank. The camouflage coating on the tank makes running and shooting more interesting. There is also a tank operator, designed to make the game more attractive. The handy-type controller is easy for use. Only one hand is enough when controlling basic moves of the tank. And you can also use it to control many complicated moves. For example, the tank runs and turns and shoots at the same time.

The tank is powered by rechargeable battery, while the controller uses eight AA batteries. If fully powered, the tank is run continuously for 30 minutes. Moreover, the tank can change different crystal for more than 1 tank to run at the same time without interference.

"Creativity, Technology, Quality" These are the 3 slogans of our company for the new century, which are embodied in our 1/16 RC battle tank series. In the future, we will try our best to offer you more quality products.

部隊番貼紙的貼法 HOW TO STICK MARK SEALS

1. 從要貼的標志從貼紙中取上來。

1. Take the proper seal with a pair of forceps.



2. 把標志貼到所需的位置，然後再從貼紙的一邊到另一邊用手緊壓一下，讓標志充分緊貼。

2. Stick the mark to you need the position, then pressing down the paster.

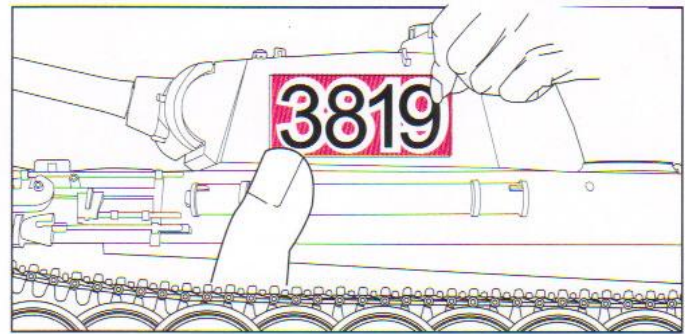

3. 待十五分鐘後，再撕下透明膜。

3. After wait for 15 minutes, then tears down the transparent film.

